

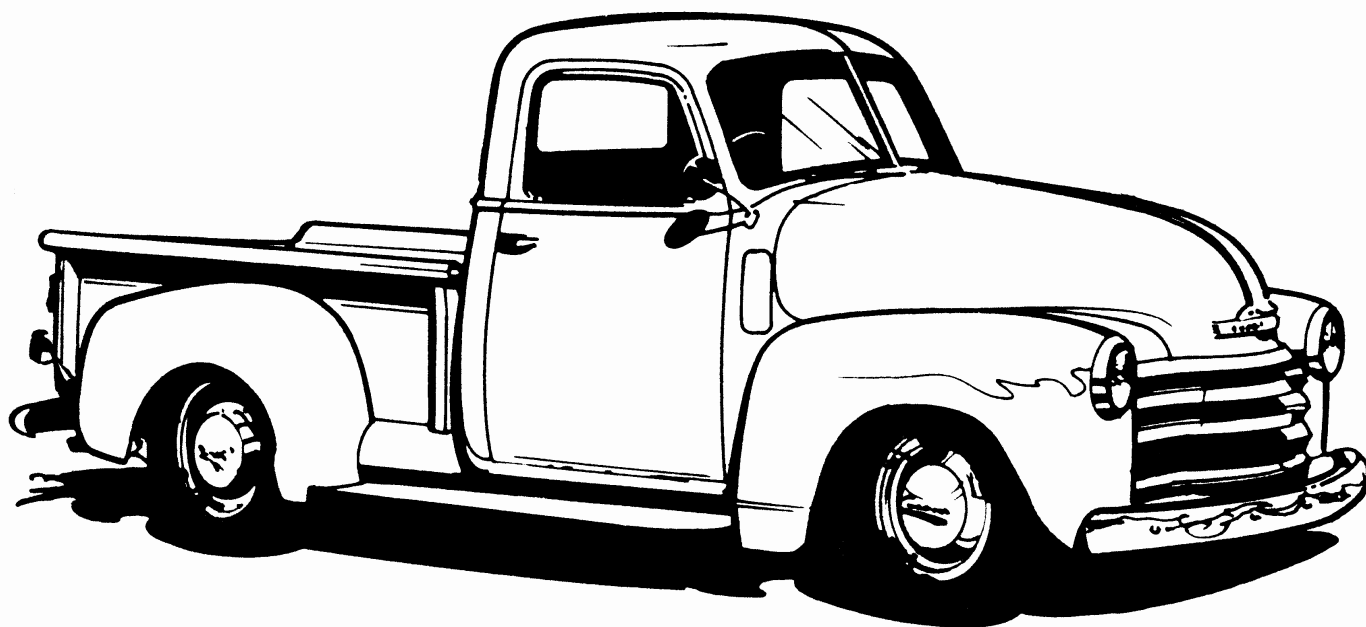

\$5.00

Chevy Pickup Trucks 1947—1972



WE ALSO STOCK

Ford Model T
Ford Model A
Ford Early V8 to 1956
Ford Pickup 1928-1972
Chevy 1955-56-57
Street Rod Components
Books and Manuals

Phone (604) 888-4412

Fax (604) 888-7455

www.oldcarcentre.com



The Old Car Centre

Ordering Information

Welcome to the Old Car Centre.

You have reached the most complete source of Street Rod & Reproduction parts and accessories available in Canada. We have been in business since 1977 providing our customers with the latest quality Street Rod Components. From accessories to frames to fibreglass bodies we would be pleased to help you get your project on the road. This catalogue is only a partial listing of products we carry in our inventory from over 200 manufacturers. If you don't find your exact needs listed, please call as new parts are continually being developed and made available.

ORDERING

Please use catalogue part numbers whenever possible to avoid confusion. Also be sure to tell us the year, body style and make of your car or pickup.

SHIPPING

Any prepaid order over \$350.00 will be shipped prepaid to any point in Western Canada by a carrier of our choice. Orders over \$450.00 will be shipped prepaid to all other Canadian destinations. Any mailable order over \$65.00 will be shipped prepaid. Under \$65.00 please add 10% for shipping. Minimum shipping Charge is \$6.00. All tires, fibreglass, headliner kits, frames and box bedwood will be shipped freight collect. We cannot be responsible for shipping damage. **If your parts are damaged during shipping, contact the carrier immediately for compensation.**

PAYMENT

In addition to accepting Visa and MasterCard on both mail and phone in orders, we also accept money orders and cheques. Please allow 10 days for your personal cheque to clear the bank. We also will ship C.O.D. by cash, money order or cashiers cheque, if you prefer. B.C. residents please add 7% provincial sales tax to all orders with the exception of books.

SPECIAL ORDERS

A 50% NON-REFUNDABLE deposit is required on all special orders. **All sales are final on non-stocking and special order items.**

RETURNS

Your satisfaction is guaranteed on all parts used as originally intended or purchase price cheerfully refunded within 30 days of purchase. Returns after 30 days however are subject to a 15% handling and restocking charge. No returns will be accepted after 90 days. Parts that have been used, painted or altered in any way are NOT returnable. **No returns will be accepted without the original invoice. Postage or shipping charges must be prepaid, as we do not accept collect shipments.** All electrical parts are NOT returnable.

MINIMUM ORDER

None: We appreciate your business

LIABILITY

We are not responsible for the use of the products in this catalogue. Neither seller nor manufacturer is liable for loss, injury or damage directly arising out of the use or misuse of said products. User assumes all risk and liabilities of the products in this catalogue.

All parts are offered subject to prior sale and are subject to price change without notice. Price quotations on special order items are valid for a period of 30 days only.

Every effort will be made to maintain current published prices but all prices are subject to change without notice

Store Hours:

Monday thru Friday 8:00 am. to 5:00 pm.
Saturday 10:00 am. to 4:00 pm.
Closed Sundays and all Statutory Holidays

The Old Car Centre

#3 – 20075 92A Avenue, Langley B.C. V1M-3A5
Phone (604) 888-4412 Fax (604) 888-7455
www.oldcarcentre.com

WHEELS

HUB CAPS

SETS OF FOUR



1947-53

47-1130 1/2 TON - STAINLESS STEEL
WITH RED LETTERS

47-1130GMC 1/2 TON - STAINLESS STEEL WITH
RED LETTERS - AS PER ORIGINAL

1954-55

54-1130 1/2 TON - STAINLESS STEEL
WITH BLUE BOW TIE

1955-56

55-1130 SMALL DELUXE - CHROME -
PAINTED IVORY IN PROPER
AREAS



1955-59

55-1130GMC 1/2 TON - CHROME
WITH RED PAINT



1957-60

57-1130 1/2 TON - CHROME
WITH BLACK PAINT



1964-66

64-1130 1/2 TON - CHROME WITH
ORANGE PAINT -
FITS 15" WHEEL WITH
BUMPS TO HOLD
CAP ON WHEEL



STAINLESS STEEL BEAUTY RINGS

SMOOTH FACE

1947-72

6A-1830314 14" WHEELS

6A-1830315 15" WHEELS

6A-1830316 16" WHEELS



RIBBED FACE

O1A-1830314 14" WHEELS

O1A-1830315 15" WHEELS

O1A-1830316 16" WHEELS

BRAKE PARTS

MASTER CYLINDER FLOOR PLUG

1947-59

47-7011136



BRAKE & CLUTCH PEDAL PADS - EACH

1947-55 1st SERIES

47-2454



1955-59

55-2454

1960-72 STANDARD

60-2454



1967-72 DELUXE WITH STAINLESS TRIM

71-2454 PAD ONLY - FOR STAINLESS

TRIM SEE BELOW



71-2455 BRAKE & CLUTCH

PEDAL STAINLESS



PARKING BRAKE PEDAL PADS

1947-53
47-2454
1960-72
69-2457



1967-72 DELUXE
71-2457 PAD ONLY



71-2459 PARKING BRAKE
PEDAL STAINLESS
STEEL TRIM



BRAKE RETURN SPRING

1947-50 1/2 TON
47-2035 FRONT & REAR



BRAKE ADJUSTER SPRING

1951-63 1/2 TON
51-2040

BRAKE & CLUTCH SHAFT FLOOR SEAL KITS

1947-51
47-2470
1952-55 1st SERIES
52-2470
1955-59
55-2470

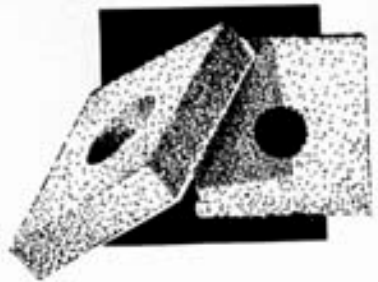

BRAKE & CLUTCH PEDAL ARM BUMPER

1947-59
47-2456 EACH

EMERGENCY BRAKE PARTS

PARKING BRAKE CABLE GROMMET

1960-72
DO-521-T

FLOOR MOUNT PARKING BRAKE SEAL

1947-59
47-35195



EMERGENCY BRAKE CABLE BOOT

SOLD EACH

1947-59
47-2597

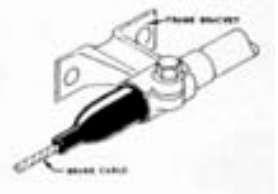

EMERGENCY BRAKE BOOT

1947-55 1st SERIES

47-7000



47-7000-A MOUNTING PLATE



EMERGENCY BRAKE KNOBS

1947-53
47-9275 CHROME

1954-55 1st SERIES
54-9275



AXLE BUMPERS

FRONT SPRING AXLE TO FRAME BUMPER

1947-55 1st SERIES (1/2 TON)
47-5783



REAR AXLE BUMPERS

1963-72 (1/2 TON)
63-5783 2WD WITH COIL SPRINGS



CHEVY PICKUP 1947 to 1972

www.oldcarcentre.com

STEERING COLUMN PARTS

UPPER COLUMN

- 1954-55 1st SERIES CLAMP SEAL
54-3639
- 1955-59 CLAMP SEAL
55-3639
- 1967-72 COLUMN TO DASH SEAL
67-3513



COLUMN TO FLOOR SEAL

- 1947-55 1st SERIES
47-35190 (3 SPEED)



- 47-35194 (4 SPEED)



- 1955-59
55-35190 (3 SPEED)



- 1967-72
67-35190 FOAM
67-35194 RUBBER



STEERING WHEEL

- 1947-53
47-3625BK BLACK
- 1954-56
54-3625BK BLACK
- 1957-59
57-3625BK BLACK
- 1960-66 STANDARD
60-3625BK BLACK
- 1967-68
67-3625BK BLACK
- 1969-72
69-3625BK BLACK
69-3625BL BLUE
69-3625G GREEN
69-3625S SADDLE
69-3625DB DARK BLUE



TILT WHEEL RELEASE LEVER

- 1967-72 CHEVROLET & GMC
67-13306

HORN PARTS

INNER HORN CONTACT PLATES

- 1947-53
47-3631



- 1954-59
55-3631



HORN CAPS

- 1947-53 1st SERIES
47-3626 CHROME WITH
PAINTED DETAILS



- 1954-55
54-3626 CHROME "BOWTIE"
WITH PAINTED
BLACK DETAILS



- 1955-56
55-3626 CHROME "BOWTIE" WITH
PAINTED BLACK DETAILS

- 1957-59
57-3626 CHROME "BOWTIE" WITH
PAINTED BLACK DETAILS

- 1960-66
60-3626 CHROME WITH BLACK BOWTIE
AND RED PAINTED DETAILS -
INCLUDES RUBBER RETAINER

- 1969-72 WITH BLUE BOW TIE
69-3626BK BLACK
69-3626BL BLUE
69-3626G GREEN
69-3626S SADDLE
69-3626DBL DARK BLUE



HORN CAP RETAINING KIT

1969-72

69-3632 MOUNTS HORN CAP TO
STEERING WHEEL

BATTERY PARTS

BATTERY TRAYS

(COMPLETE)

1947-55 1st SERIES

47-5151

1955-57

55-5151

55-5150 TRAY - BOTTOM TRAY ONLY

1958-59

58-5151

1960-66

60-5151

1967-72

67-5151 WITHOUT A/C

67-5151WA WITH A/C

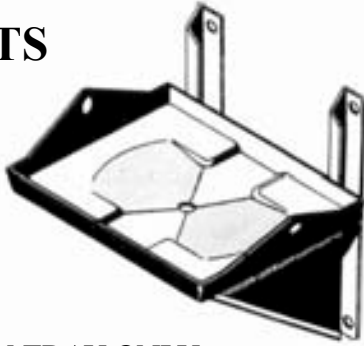

BATTERY HOLD DOWN

1947-55 1st SERIES

47-5165



1955-57

CB-312



1958-66

CB-314



1955-66

CB-312B HOLD DOWN BOLTS - EACH



MOUNTING KITS

CAB TO FRAME MOUNTING KITS

(INCLUDES ALL PADS & HARDWARE)

1947-55 1st SERIES

47-5001 1/2 TON - 1 TON

1955-59

55-5001 1/2 TON - 1 TON

1960-66

60-5001 1/2 TON

1967-72

67-5001 1/2 TON



RADIATOR SUPPORT CUSHIONS

1955-66

55-8130 SET OF 4

ENGINE MOUNTS - CUSTOM

1947-59 V-8

47-5019 UNIVERSAL SADDLE TYPE FRAME
MOUNT USED ON 265-350 ENGINES
INTO AN OPEN FRAME CHANNEL
(3 PCS SET)



6650 SMALL BLOCK V8 MOTOR MOUNTS
(USED WITH 47-5019 & 6626)



1955-59

6626 SIDE MOUNT TYPE BRACKETS

MOTOR MOUNTS - ORIGINAL

1947-55 1st SERIES

47-6038F FRONT (6CYL)



47-6038P FRONT BASE
PLATE



1947-53

47-6038R REAR (1/2 TON, 6CYL)



CHEVY PICKUP 1947 to 1972

www.oldcarcentre.com

1955-59
55-6038 COMPLETE FRONT
MOTOR MOUNT KIT (V8)



ENGINE DECALS

THRIFTMASTER VALVE COVER DECALS

1947-53
47-6582 "216" 6CYL (YELLOW LETTERS)

Thrift master



1954-55 1st SERIES
54-6582 "235" 6CYL (YELLOW LETTERS)

OIL FILTER CANISTER DECALS

1947-55 1st SERIES
47-6720-AC "AC"
47-6720-FM "FRAM"



TRANSMISSION

TRANSMISSION CROSSMEMBER KIT - CUSTOM

1947-59
47-5025 BOLTS OR WELDS TO FRAME TO
ACCEPT A LATE MODEL
TRANSMISSION



6660 RUBBER MOUNT FOR ABOVE
CROSSMEMBER - SPECIFY
TRANSMISSION



1955-59
6704 BOLT IN TRANSMISSION
CROSSMEMBER

TRANSMISSION INDICATOR HOUSING

1962-66
62-3505A CHROME - AUTOMATIC
1971-72
71-3505WT BLACK - WITH TILT
71-3505WTC CHROME - WITH TILT
71-3505NT BLACK - WITHOUT TILT

TRANSMISSION INDICATOR LENS

1962-66
62-3510A
1970-72
70-3510WT TILT COLUMN
70-3510 WTWO WITH TILT AND OVERDRIVE
1971-72
71-3510NT WITHOUT TILT



TRANSMISSION INDICATOR POINTERS

1970-72
70-3515WT WITH TILT
1971-72
71-3515NT WITHOUT TILT

CLUTCH PARTS

1947-59
47-7522 LINKAGE - TO - OFFSET ROD
(ATTACHES TO PEDAL ARM)



47-7521 CLUTCH OFFSET ROD
(ATTACHES TO CLUTCH FORK)

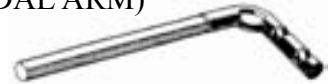

1960-72
60-7514 CLUTCH FORK BOOT



SHIFTER PARTS

SHIFT KNOB

1940-59 (4- SPEED)
47-7213 BLACK



1947-53 (3 SPEED & AUTO)
47-7214 MAROON



1954-55 (3 SPEED & AUTO)
54-7214 BLACK (1st SERIES)



1955-59 (3 SPEED & AUTO)
55-7214 BLACK



1960-66 (3 SPEED & AUTO)
60-7214 BLACK

1967-70 (3 SPEED & AUTO)
67-7213 BLACK



1971-72 (3 SPEED & AUTO)
71-7214OG BLACK

COLUMN SHIFT PARTS

1947-59
47-7244 COLUMN SHIFT LEVER,
RETAINING PINS, SPRING &
RUBBER BUSHINGS



47-7246 SHIFTER BOOT - MOUNTS ON
COLUMN SHIFT BOX



1947-66
47-7227 SHIFT ROD GROMMET
C/WITH INNER SLEEVE



1960-66
60-7213SL 3SPD/AUTO -
CHROME SHIFT LEVER



1967-68
67-7213SLNT - 3 SPD AUTO - WITHOUT TILT
- CHROME

1969-70
69-7213SLNT - AUTO - WITHOUT TILT -
CHROME

1971-72
71-7213SLNT - 3 SPD / AUTO - WITHOUT TILT
- CHROME

71-7213SLWT - 3 SPD/AUTO - WITH TILT -
CHROME

FLOOR TRANSMISSION SHIFTER BOOT

1947-66
47-7242 RUBBER BOOT
47-35196 SEAL (4 SPEED)



1967-72
67-7243 4X4 TRANSFER CASE
1968-72
68-7242-2WD 2WD - 4 SPD - SMALL BLOCK
1968-70
68-7242-4WD 4WD - 4 SPD - 1/2 TON - 3/4 TON

GRILL ASSEMBLY

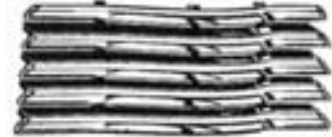

1947/53
47-8200B PAINTED BLACK - CHEVROLET
47-8200C CHROME FRONT BARS W/BLACK
PAINTED BACK - CHEVROLET
47-8200GMC CHROME WITH CREAM COLOR
BACK BARS - GMC

1954-55 CHEVROLET
54-8200C CHROME
54-8200B BLACK
54-8204C CHROME GRILL NOSE
54-8204B BLACK GRILL NOSE



1955-56 CHEVROLET
55-8200C CHROME



1957 CHEVROLET
57-8200C CHROME



1958-59 CHEVROLET
58-8200C CHROME

1964/66
64-8200C CHROME W/ CHEVROLET SCRIPT



CHEVY PICKUP 1947 to 1972

www.oldcarcentre.com

1967-68
67-8200 ALUMINUM GRILL MOLDINGS



1967 GMC
67-8200GMC CHROME WITH BLACK PAINTED
DETAILS



1968-70 GMC
68-8200GMC CHROME WITH BLACK PAINTED
DETAILS

1969-70
69-8200 GRILL SHELL (NO CHEVROLET
LETTERING)

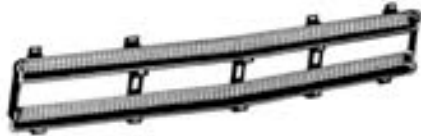

69-8201 INNER GRILL WITH BLACK AND
SILVER PAINTED DETAIL



1971-72 CHEVROLET
71-8200 OUTER GRILL SHELL - ALUMINUM
WITH BLACK PAINTED DETAIL

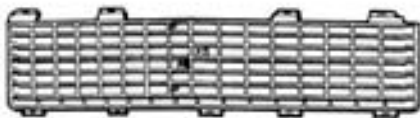

71-8201 INNER GRILL, GRAY



1971-72 GMC
71-8200GMC CHROME WITH BLACK
PAINTED DETAIL

GRILL EMBLEM



1967-68
67-8212 GRILL EMBLEM - CHROME WITH
RED DETAIL

GRILL INSTALLATION KIT

1969-72 CHEVROLET
69-8206 INNER AND OUTER GRILL KIT,

GRILL SUPPORT

1958-59 CHEVROLET
58-8205



GMC TOP GRILL BAR MOLDING

1958-72
69-80000UGMC
CHROME,

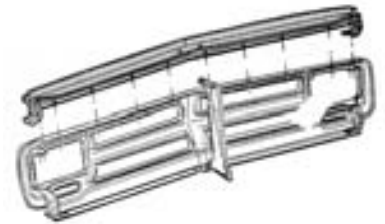

GRILL MOLDING CLIP SET

1967-68 CHEVROLET
67-8202 MOUNTS ONE MOLDING

LOWER GRILL VALANCE

1955-56 CHEVROLET
55-8203 EACH
1957 CHEVROLET
57-8203 EACH



GRILL MOUNTING BRACKET

1969-72 CHEVROLET
69-8208L LEFT HAND
69-8208R RIGHT HAND,

FUEL TANKS

STOCK TANKS - STAMPED STEEL

1949-55 1st SERIES

- 49-9310
- 1955-59
- 55-9310
- 1960-66
- 60-9310
- 1967-71
- 67-9310
- 1972
- 72-9310

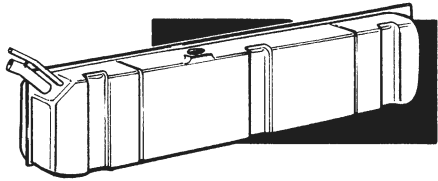

FUEL SYSTEM

FILLER NECK GROMMETS

1947-55
47-9080 1st SERIES



1947-55 PANEL & SUBURBAN
47-9080PS



1955-59
55-9080



1960-66
60-9080



1967-70
67-9080



1971-72
71-9080

GAS TANK FILLER NECK PARTS

1960-66
60-9085 FILLER NECK HOSE



FUEL TANK FILLER KIT

1947-55
47-9308KIT WITH CHROME GAS CAP
1955-59
55-9308KIT WITH CHROME GAS CAP

GAS TANK SENDING UNIT WITH FLOAT AND GASKET

1947-59
47-9300 REPLACEMENT FOR
1947-55 1st SERIES -
CORRECT FOR 1955-1959
1960-66
60-9300
1967-71
67-9300-6 (6CYL)
67-9300-8 (8CYL)
1972
72-9300A AUTO TRANSMISSION
72-9300S STANDARD TRANSMISSION

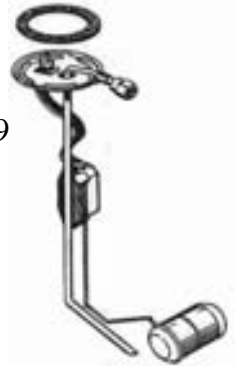

GAS TANK SENDER PARTS

1947-66
CA-1488 SCREWS & WASHERS
(SET OF 5)
CA-195C MOUNTING GASKET
1967-72
67-9305 GASKET
1947-72
47-9312 FLOAT ONLY
1955-59
CB-195D FILTER



GAS TANK SEALER

SEALS GAS TANK WALLS THAT ARE PEELING
AND CORRODED WITH AGE.
ALSO SEALS MINOR LEAKS. 1 QUART DOES
ONE TANK.
M-600



CHEVY PICKUP 1947 to 1972

www.oldcarcentre.com

GAS TANK ETCH

WILL REMOVE LIGHT BUILDUP OF RUST INSIDE OF ALL TANKS & WILL ETCH THE INSIDE OF THE TANK LEAVING A GRAY PHOSPHATE COATING. AN EXCELLENT PREP FOR YOUR TANK BEFORE INTRODUCING GAS TANK SEALER, TE-01.



LOCKING GAS CAPS

1947-63 LOCKING GAS CAP
BT-18416 CHROME W/TWO KEYS & BOW TIE EMBLEM ON LOCK COVER

1947-71
47-18416C CHROME LOCKING GAS CAP

GAS CAP

1938-71 1/2 TON & 1971-72 3/4 - 1 TON
38-18416SS



CHOKE CABLE PARTS

CHOKE CABLE & KNOB

1947-53
47-9700C



1954-55 1st SERIES
54-9700C



1955-59
55-9700C CHROME



55-9700CB BLACK



1960-63
60-9700C



CHOKE KNOBS

1954-55 1st SERIES
54-9701C



1964-66
64-9700C



THROTTLE CABLE PARTS

THROTTLE CABLE & KNOB

1947-53
47-9700T



1954-55 1st SERIES
54-9700T



1955-59
55-9700T CHROME



55-9700TB BLACK



1960-63
60-9700T



THROTTLE KNOB

1954-55 1st SERIES
54-9701T



ACCELERATOR PEDALS & PARTS

ACCELERATOR PEDALS

1947-52
47-9735



1953-57
53-9735



1958-59
58-9735



1960-63
60-9735



1964-66
64-9735



1967-70
67-9735 DELUXE
67-9735S STANDARD



1971-72
71-9735

ACCELERATOR PEDAL TRIM STAINLESS STEEL

1967-70
67-9736



1971-72
71-9736



ACCELERATOR PEDAL PARTS

1947-59
47-9730 PEDAL SHAFT FLOOR SEAL



1947-57
53-9735R COTTER PIN & ROD



DASH PARTS

DASH PADS (WITH HARDWARE)

1967-72
67-9200BK BLACK
67-9200S SADDLE
67-9200BL BLUE
67-9200G GREEN
67-9200R RED
67-9200GY GRAY



CHROME DASH KNOB

1955-59
55-9270 3/16" HOLE (EACH)



CENTRE DASH SETS

1947-53 CHEVROLET

47-9269C INCLUDES PAINTED SPEAKER GRILL,
UPPER & LOWER STAINLESS MOLDINGS, ASH
TRAY ASSEMBLY, CHROME KNOBS.
47-9269GMC SAME AS ABOVE (GMC)

DASH INDICATOR HOUSING

1967-72
67-9268R HIGHBEAM WITH RED LENS
67-9268G TURN SIGNAL WITH GREEN LENS -
SOLD EACH

DASH INSTRUMENT BEZELS

1947-53
47-9271 CHROME - FITS AROUND
SPEEDOMETER & GAUGE
CLUSTER (EA)



1954-55 1st SERIES
54-9271SS STAINLESS STEEL
54-9271C CHROME

1955-59
55-9271 CHROME



CHEVY PICKUP 1947 to 1972

www.oldcarcentre.com

- 1967-68
 67-9271B BLACK WITH CHROME EDGES
 67-9271C CHROME



- 1969-72
 69-9271B BLACK
 W/CHROME EDGES
 69-9271C ALL CHROME
 69-9271B3 BLACK WITH CHROME EDGES -
 3 HOLE
 69-9271C3 CHROME - 3 HOLE

DASH BEZEL APPLIQUES

- 1967-68
 67-9281W WOODGRAIN
 1969-72
 69-9281W WOODGRAIN

DASH BEZEL INSTRUMENT SOCKET & BULB

- 1967-72
 67-9267

INSTRUMENT PANEL LENS

- 1955-59
 55-9271L PLASTIC LENS
 C/W NUMBERS
- 1967-72
 67-9271L3 3 HOLE
 67-9271LNT W/O TACHOMETER W/O VACUUM
 67-9271LWTWV WITH TACHOMETER AND
 VACUUM
 67-9271LWT WITH TACHOMETER W/O
 VACUUM



DASH PRINTED CIRCUIT BOARD

- 1967-72
 67-9266-3 USE WITH 3 HOLE DASH CLUSTER
 67-9266NT WITHOUT TACHOMETER
 67-9266WT WITH TACHOMETER

DASH WINDOW MOLDING CLIPS

- 1955-59
 55-9278 STEEL (8 PCS)

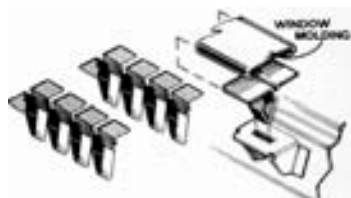

SPEEDO & GAUGE CLUSTER ASSEMBLIES

COMPLETE ASSEMBLIES

WITH BEZEL AND BACKING PLATES

- 1947-49 CHEVROLET
 47-9260ASM SPEEDO CLUSTER 0-80 MPH
 47-9276ASM1 GAUGE CLUSTER 6V - 6CYL
 47-9276ASM2 GAUGE CLUSTER 12V - 8CYL

- 1950-53
 50-9260ASM SPEEDO CLUSTER 0-90 MPH
 50-9276ASM1 GAUGE CLUSTER 6V - 6CYL
 50-9276ASM2 GAUGE CLUSTER 12V- 8CYL

INDIVIDUAL GAUGES & PARTS

SPEEDOMETER GAUGES

- 1947-49
 47-9260 0-80 MPH
 1950-53
 50-9260 0-90 MPH



- 1955-59
 55-9260



- 1967-72
 67-9260



GAUGE FACE DECALS

- PEEL AND STICK (SETS)
 1947-49
 47-17255 80-MPH & 212 -
 DEGREE READING



- 1947-53
 47-17255GMC "GMC" 80-MPH
 READING
 1950-53
 50-17255 90-MPH & 220-DEGREE
 READING

1954-55
54-17255 1st SERIES 90-MPH
READING

1955-59
55-17255 GAS, TEMP, OIL, AMP &
ODOMETER

SPEEDOMETER NEEDLE

1947-53
47-17261



1955-59
55-17261



SPEEDOMETER CABLE

1947-72
47-17260 (68")
47-17260MH 70" WITH METAL HOUSING



SPEEDO CABLE THRU-FIREWALL GROMMET

1954-55 1st SERIES
CA-92



FUEL GAUGES

1947-49
47-9262-6V RED NEEDLE - 6 VOLT
47-9262-12V RED NEEDLE - 12 VOLT
1950-53
50-9262-6V WHITE NEEDLE - 6 VOLT
50-9262-12V WHITE NEEDLE - 12 VOLT



1955-59
55-9262



1967-72
67-9262

BATTERY GAUGES

1947-49
47-9264 RED NEEDLE
1950-53
50-9264 WHITE NEEDLE
1955-59
55-9264 AMMETER GAUGE
1967-72
67-9264 AMMETER GAUGE



OIL PRESSURE GAUGES

1947-49
47-9265 0-30 LBS - RED NEEDLE
47-9265-60 0-60 LBS - RED NEEDLE
1950-53
50-9260 0-30 LBS - WHITE NEEDLE
50-9265-60 0-60 LBS - WHITE NEEDLE
1955-59
55-9265
1967-72
67-9265

VACUUM GAUGE

1967-72
67-9277

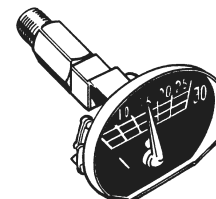

TEMPERATURE GAUGES

1947-49
47-9263-6 6 CYL - RED NEEDLE
47-9263-8 8 CYL - RED NEEDLE
1950-53
50-9263-6 6 CYL - WHITE NEEDLE
50-9263-8 8 CYL - WHITE NEEDLE
1955-59
55-9263 ELECTRIC
1967-72
67-9263 ELECTRIC



TACHOMETER GAUGE

1967-72
67-9261



CHEVY PICKUP 1947 to 1972

www.oldcarcentre.com

ASHTRAY / LIGHTER PARTS

CIGARETTE LIGHTER & ELEMENT

1947-53

47-15052 MAROON AND
STAINLES STEEL KNOB



1954-55 1st SERIES

54-15052 BLACK KNOB



1955-59

55-15052 CHROME KNOB



1960-63

60-15052 BLACK AND
STAINLESS STEEL KNOB



1964-66

64-15052 BLACK AND
STAINLESS STEEL KNOB



1967-72

67-15052 BLACK AND
STAINLESS STEEL KNOB



ASH TRAY ASSEMBLY

1967-72

67-15059B BLACK FACE
67-15059C CHROME FACE

CIGARETTE LIGHTER KNOB

1954-55 1st SERIES

54-15054



ASH TRAY KNOB

1947-53

47-15053 CHROME



IGNITION PARTS

IGNITION SWITCH HOUSING

1947-53

47-11572

1954-55 1st SERIES

54-11572

1955-56 V8

CA-119



IGNITION SWITCH CYLINDER & KEYS

1947-66

47-11582



IGNITION INDICATOR PLATE

1955-59

55-11584 V8 (PLASTIC)

1967-72

67-11584



IGNITION SWITCH RETAINER NUT

1955-59

55-10852 STAINLESS STEEL

1968-72

68-11570 CHROME BEZEL NUT

68-11569 IGNITION SWITCH SPACER



STARTER

FOOT STARTER PEDAL PAD

1947-55 1st SERIES

47-11471



STARTER RETURN SPRING

1947-59

47-9737



STARTER BELLOW BOOT

1947-59

47-11472 FOOT STARTER
THROUGH FLOOR SEAL



STARTER WIRE GROMMET

1955-59

CA-915



RADIO PARTS



AM/FM CASSETTE STEREO / CD

1947-72

DESIGNED TO FIT IN THE STOCK DASH
OPENING - PLEASE CALL FOR PRICING AS
THERE ARE A VARIETY OF MODELS TO CHOOSE
FROM

DUAL SPEAKER PACKAGE

1947-72 SPECIFY YEAR

CB-17A FITS IN STOCK SPEAKER
LOCATION

SPEAKER GRILL COVER

1955-59

55-9290C CHROME
55-9290B BLACK



RADIO KNOBS

1947-53

47-9270 TAN (SET)

1954-55 1st SERIES

54-9270 BLACK (SET)

54-9270-GMC GRAY (SET)



1955-59

55-9270 DASH/RADIO KNOB
CHROME (3/16" HOLE)



1960-63

60-9270 RADIO KNOB, BLACK &
STAINLESS STEEL



1964-66

64-9270 RADIO KNOB BLACK &
STAINLESS STEEL



RADIO HOUSING

1947-53

47-9280 MAROON



RADIO FLIPPER KNOBS

1955-59

55-18805 CHROME/PLASTIC (PR)



RADIO PUSH BUTTONS

1947-53

47-9272 TAN (5 PCS)



ANTENNA

TELESCOPIC - INCLUDES CABLE & HARDWARE

1947-55 1st SERIES

47-9285

1955-59

55-9285

1960-62

60-9285

1963

63-9285

1964-66

64-9285

1967-72

67-9285

63C-9284MST - TELESCOPIC MAST ONLY



CHEVY PICKUP 1947 to 1972

www.oldcarcentre.com

HEADLIGHT SWITCH & PARTS

HEADLAMP SWITCH (LESS FUSE AND KNOB)

1947-55

- 47-11664-OG6V 6 VOLT - ORIGINAL DESIGN
- 47-11664-OG12V 12 VOLT - ORIGINAL DESIGN
- 47-11664-6V 6 VOLT - REPLACEMENT TYPE
- 47-11664-12V 12 VOLT - REPLACEMENT TYPE

1955-57

CA-117A

1964-72

64-11664



HEADLIGHT SWITCH RETAINING NUT

1955-59

55-11663 STAINLESS STEEL



HEADLIGHT SWITCH ROD & KNOB

1947-53

47-11661



1954-55 1st SERIES

54-11661



1955-59

55-11661 CHROME



1960-63

60-11661



1964-66

64-11661



1967

67-11661



1968-72

68-11661 DELUXE
(W/STAINLESS CENTRE)



HEADLIGHT ROD KNOB

1954-55 1st SERIES

54-11662



WIRING

FUSE PANEL

1955-59

CA-1347

INNER FENDER TERMINAL JUNCTION BOX

1947-55 1st SERIES

47-12252-3 THREE PRONG



47-12252-4 FOUR PRONG



MAIN WIRING HARNESS THRU FIREWALL

GROMMET

1947-59

47-14603



4-HOLE WIRE HARNESS GROMMET

1955-59

CA-820



HEADLIGHT PARTS

HEADLIGHT BUCKET & BULB ASSEMBLIES

1947-55

47-13055 12 VOLT

1955-57

55-13055 12 VOLT



HEADLIGHT BEZELS

SOLD AS PAIRS

1947-55 1st SERIES

47-13045 STAINLESS STEEL



1955-57

55-13045C CHROME

W/INSTALLATION SEALS



1958-59

58-13045C CHROME



1963
63-13045 CHROME



1964-66
64-13045C CHROME



1967-68
67-13045 ALUMINUM



1969-72
69-13045 ALUMINUM
69-13045GMC GMC CHROME



HEADLIGHT BEZEL SEALS

1947-57
CA-864 W/WIRE CORE



HEADLIGHT BEZEL CLIPS

1947-55
47-13061 (SET)

HEADLIGHT RETAINING RING

1947-54 CHEVROLET & GMC
41-13040
1955-57 CHEVROLET & GMC
55-13040 STAINLESS STEEL
1962-72 CHEVROLET
41-13040



**HEADLIGHT BUCKET WIRE HARNESS
RUBBER GROMMETS**

1955-57
CA-835 (PR)

**HEADLIGHT BUCKET-TO-FENDER
GASKETS**

1947-57
CA-865 (PR)



**HEADLIGHT & PARKING LIGHT WIRE
GROMMET (THRU-INNER FENDER PANEL)**

1956-57
56-16085 (PR)

PARK LIGHTS

COMPLETE PARKING LIGHT ASSEMBLIES

1947-53 CHEVROLET
47-13200 (6 VOLT)
47-13200TS WITH TURN SIGNAL (12 VOLT)



1954-55 CHEVROLET 1st SERIES
54-13200 (12 VOLT)
54-13200TS WITH TURN SIGNAL (12 VOLT)



1955-57 CHEVROLET
55-13200C WITH CLEAR LENS (12 VOLT)
55-13200A WITH AMBER LENS



1958-59 CHEVROLET
58-13200C WITH CLEAR LENS
58-13200A WITH AMBER LENS

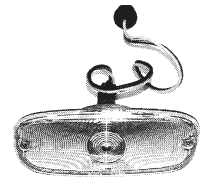

1967-68 CHEVROLET
67-13200L L/H WITH AMBER LENS
67-13200R R/H WITH AMBER LENS



1971-72 CHEVROLET
71-13200L L/H WITH AMBER LENS
71-13200R R/H WITH AMBER LENS



CHEVY PICKUP 1947 to 1972

www.oldcarcentre.com

**PARKING LIGHT TURN SIGNAL
CONVERSION KITS - SOLD EACH**



1947-53
47-13205TS INCLUDES WIRING BRACKET &
BULB (12 VOLT)
1954-55 1st SERIES
54-13205TS INCLUDES WIRING & SOCKET
(12 VOLT)

PARKING LIGHT LENS

1947-50 GMC
47-9810 GLASS

1947-53 CHEVROLET
47-13208 GLASS



1954-55 1st SERIES
54-13208A AMBER
54-13208C CLEAR

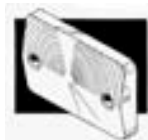

1955-57
55-13208A AMBER
55-13208C CLEAR



55-13208GMC "GMC" R/H CLEAR
55-13209GMC "GMC" L/H CLEAR



1958-59
58-13208A AMBER
58-13208C CLEAR



1960-66
60-13208A AMBER
60-13208C CLEAR



1960-66 GMC
62-13208GMCA R/H AMBER
62-13209GMCA L/H AMBER
62-13208GMCC R/H CLEAR
62-13209GMCC L/H CLEAR



1967-68
67-13208 R/H AMBER
67-13209 L/H AMBER
67-13208C R/H CLEAR
67-13209C L/H CLEAR

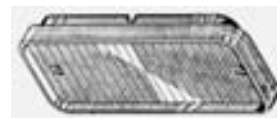

1967-72 GMC
67-13208GMC AMBER

1969-70 CHEVROLET
69-13208 R/H CLEAR
69-13209 L/H CLEAR



1971-72 CHEVROLET
71-13208 R/H AMBER
71-13209 L/H AMBER
71-13208C R/H CLEAR
71-13209C L/H CLEAR



PARKING LIGHT BEZELS

1947-53
47-13210 CHROME
1958-59
58-13210 CHROME
1962-66
62-13210 ALUMINUM



PARKLIGHT LENS GASKETS

1947-53
47-13211 (PR)



1954-55 1st SERIES
54-13211 (PR)



1955-57
55-13211 (PR)



55-13211GMC "GMC" (EA)



1958-59
58-13211 (PR)

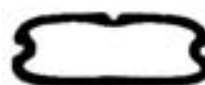

1960-66
60-13211 (PR)



1962-66 GMC
62-13211GMC (PR) 

1967-68
67-13211 (PR) 

1969-70
69-13211 (PR) 

1971-72
71-13211 (PR) 

PARKLIGHT ASSEMBLY TO BODY SEALS

1955-57
55-13212 (PR) 

SIDE MARKER LIGHTS

1968-72
68-13100S FRONT STANDARD
- AMBER 

68-13150S REAR STANDARD
- RED

68-13100D FRONT DELUXE
- AMBER 

68-13150D REAR DELUXE
- RED

TAIL LIGHTS

COMPLETE TAIL LIGHTS (SOLD EACH)

1940-53 
47-13404B BLACK W/CHROME BEZEL (RH)
47-13405B BLACK W/CHROME BEZEL (LH)
47-13404C ALL CHROME (RH)
47-13405C ALL CHROME (LH)

1954-55 1st SERIES 
54-13405B BLACK WITH
STAINLESS STEEL BEZEL
54-13405SS ALL STAINLESS STEEL

1955-59
55-13405B BLACK WITH
STAINLESS STEEL
BEZEL
55-13405SS ALL STAINLESS
STEEL 

1960-66
60-13405B BLACK
60-13405SS ALL STAINLESS
STEEL 

1967-72
67-13405B BLACK
67-13405SS STAINLESS STEEL 

TAIL LIGHT WIRE CONDUIT

1947-72 STEPSIDE
PU-14578 STAINLESS STEEL 

TAIL LIGHT BEZELS SOLD EACH

1940-53
47-13448 CHROME 

1954-55 1st SERIES
54-13448 CHROME 

1955-59
55-13448 STAINLESS
STEEL

1958-59 FLEETSIDE
58-13448 ALUMINUM 

1960-66 FLEETSIDE
60-13448F ALUMINUM 



CHEVY PICKUP 1947 to 1972

www.oldcarcentre.com

1967-68 FLEETSIDE
 67-13448F L/H
 67-13449F R/H
 67-13447C CLIP KIT

1969-72 FLEETSIDE
 69-13448F L/H
 69-13449F R/H
 69-13447C CLIP KIT

GLASS BLUE DOTS
 W/CHROME BEZELS
 A-13450BDG (EA)



TAIL LIGHT LENSES

1940-53
 47-13450 GLASS
 47-13450BD W/BLUE DOT



1947-56 PANEL TRUCK
 47-13450PNL GLASS

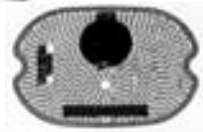

1954-55 1stSERIES
 54-13450 PLASTIC



1955-59 STEPSIDE
 55-13450 PLASTIC

1956-66 GMC STEPSIDE
 56-9150 ALSO FITS COM. VEHICLES



1958-59 FLEETSIDE
 58-13450F PLASTIC



1960-66 STEPSIDE
 60-13450 PLASTIC



1960-66 FLEETSIDE
 60-13450F PLASTIC WITH BOWTIE



1967-72 STEPSIDE
 67-13450S PLASTIC



1967-72 FLEETSIDE
 67-13450F PLASTIC
 67-13450FC CLEAR PLASTIC



1967-72 SUBURBAN
 67-13450SB

TAIL LIGHT LENS GASKETS

FLEETSIDE
 1958-59
 58-13460F (PR)
 1960-66
 60-13460F (PR)
 1967-72
 67-13460F (PR)



STEPSIDE
 1955-59
 55-13460 (EA)
 1967-72
 67-13460 (PR)



CAMEO
 1955-58
 55-13460C

TAIL LIGHT BRACKETS

1947-53
 47-13470B BLACK (RH)
 47-13471B BLACK (LH)
 47-13470C CHROME (RH)
 47-13471C CHROME (LH)

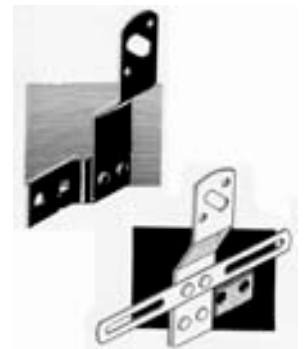

1954-55 1stSERIES
 54-13470B BLACK (RH)
 54-13471B BLACK (LH)
 54-13470C CHROME (RH)
 54-13471C CHROME (LH)

1955-66
 55-13470B BLACK (RH)
 55-13471B BLACK (LH)
 55-13470C CHROME (RH)
 55-13471C CHROME (LH)



1967-72
 67-13470B BLACK (RH)
 67-13471B BLACK (LH)
 67-13470SS STAINLESS (RH)
 67-13471SS STAINLESS (LH)



BACKUP LENS

1960-66 FLEETSIDE
 60-13455 GLASS LENS
 60-13458 GASKET (PR)
 60-13457 HOUSING TO BODY GASKET
 1967-72 FLEETSIDE
 67-13454 L/H
 67-13455 R/H
 67-13215 GASKET (PR)



TAIL LIGHT LICENCE LENS

1947-53
 47-13445 CLEAR PLASTIC
 47-13447 GASKET



TURN SIGNALS

TURN SIGNAL SWITCH ASSEMBLY
 UNIVERSAL (CLAMPS TO OUTSIDE OF COLUMN)
 A-13340TS
 A-13340F 6 VOLT FLASHER



TURN SIGNAL SWITCH

1954-56
 54-13000
 1957-59
 57-13000



1960-62
 60-13000
 1963
 63-13000
 1964-66
 64-13000
 1967-72 CHEV & GMC
 67-13000NT WITHOUT TILT
 67-13000WTAT WITH TILT & AUTO TRANS.
 1969-72 CHEV & GMC
 67-13000WTMT WITH TILT & STANDARD TRANS.



TURN SIGNAL REPAIR KITS
 - KITS INCLUDE MECHANISM, SPRING RETAINERS AND BUSHINGS

1960
 60-13301
 1961-62
 61-13301



TURN SIGNAL HOLD DOWN BOLT W/WASHER
 1960-62
 60-13301SK



TURN SIGNAL WEDGE
 1954-59
 54-13340W

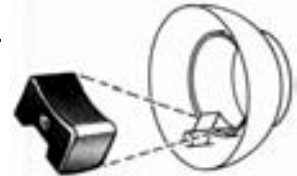

TURN SIGNAL CANCELLING PLATE

1954-59
 54-13304



1960-66
 60-13304 W/OUT TILT



CHEVY PICKUP 1947 to 1972

www.oldcarcentre.com

TURN SIGNAL LEVER CAM

1963
63-13302 W/OUT TILT



1964-66
64-13302 W/OUT TILT



1967-72
67-13302 ALL



TURN SIGNAL LEVER & KNOB

1955-59
55-13305



1960
60-13305



1961-62
61-13305



1963-66
63-13305



1967-72
67-13305
67-13306 TILT WHEEL LEVER C/W KNOB



LICENCE PLATE BRACKETS

FRONT LICENCE PLATE BRACKETS

1947-53
47-5034B BLACK
47-5034C CHROME



1954-55 (1st SERIES)
54-5034B BLACK
54-5034C CHROME



1955-57
55-5034B BLACK



1958-59
58-5034B BLACK



REAR LICENCE PLATE BRACKET & LAMP ASSEMBLY

1954-59
54-13475 BLACK
1960-66
60-13475 BLACK
1967-72 FLEETSIDE & STEPSIDE
67-17765 BUMPER FILLER PANEL



DOME LIGHT PARTS

DOME LAMP ASSEMBLIES

1947-55 1st SERIES
47-13771 PAINTED BASE
47-13771C CHROME BASE



1955-59
55-13771 W/WIRING -
CHROME BASE



1960-72
60-13771 W/WIRING -
WHITE BASE
60-13771C W/WIRING -
CHROME BASE



DOME LAMP LENS

1955-59
55-13783

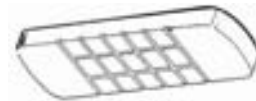

1960-72
60-13783



CARGO LIGHT

1969-72
69-13772 CARGO LIGHT ASSEMBLY
69-13782 CARGO LIGHT LENS
69-13773 CARGO LIGHT WIRING HARNESS
69-13774 CARGO LIGHT SWITCH



HOODS



- 1967-68
- 67-16730 HOOD
- 67-16730C HOOD WITH COWL INDUCTION
- 1969-72
- 69-16730 HOOD
- 69-16730C HOOD WITH COWL INDUCTION

HOOD PARTS

HOOD TO COWL SEALS



- 1947-55
- 47-16740 INCLUDES RETAINING CLIPS
- 1955-59
- 55-16740 INCLUDES RETAINING CLIPS
- 1960-66
- 60-16740
- 1967-72
- 67-16740



HOOD BUMPER KIT

- 1947-55
- 47-16761 (10 PCS)
- 1955-59
- 55-16761 (10 PCS)
- 1960-61
- 60-16761 (4 PCS)
- 1962-66
- 62-16761 (6 PCS)
- 1967-72
- 67-16761 (4 PCS)



HOOD HINGES

- SOLD EACH
- 1947-55 1st SERIES C/W SPRINGS
- 47-16785 L/H
- 47-16786 R/H
- 1955-57 C/W SPRINGS
- 55-16785 L/H
- 55-16786 R/H
- 1958-59 C/W SPRINGS
- 58-16785 L/H
- 58-16786 R/H
- 1960-66
- 60-16785 L/H
- 60-16786 R/H
- 1967-72
- 67-16785 L/H
- 67-16786 R/H



HOOD HINGE SPRINGS

- 1955-57
- CB-475 EACH
- 1958-59
- 58-16789 PAIRS



HOOD HINGE TO HOOD SHOULDER BOLT KIT

- 1947-55
- 47-16791 1st SERIES (6 PCS)



ROUND HOOD STOP BUMPER

- 1955-59
- CA-222 ON TOP OF FIREWALL (EA)

HOOD LATCH

- 1967-68
- 67-16777
- 1969-70
- 69-16777
- 1971-72
- 71-16777



CHEVY PICKUP 1947 to 1972

www.oldcarcentre.com

HOOD EMBLEMS

HOOD SIDE EMBLEMS

FASTENERS INCLUDED

1947-49
47-16721TM CHEVROLET THRIFTMASTER (PR)



1947-52
47-16721 CHEVROLET HOOD SIDE EMBLEM (PR)



1950-52
50-16721 "3100" HOOD SIDE EMBLEM (PR)



1953-55
53-16721 "3100" HOOD SIDE EMBLEM (PR)



1955
55-16721HS 3100 CHEVROLET (PR)



1960
60-16721 "CHEVROLET APACHE 10"
HOOD SIDE EMBLEM (PR)



1961
61-16721 "APACHE 10" HOOD
SIDE EMBLEMS (PR)

FRONT HOOD EMBLEMS

INCLUDES MOUNTING
HARDWARE



1947-53 CHEVROLET WITH BOWTIE
47-16721FS STAINLESS STEEL
47-16721FC CHROME
47-16721GSKT HOOD EMBLEM GASKET
1956
56-16721FC CHROME C/W RED BOWTIE
1957
57-16721FC CHROME C/W BLACK BOWTIE



1967-68
67-16721FC CHROME "CHEVROLET"



1968-72
68-16721FCG CHROME "GMC"

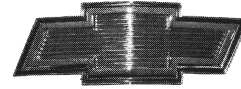

1969-70
69-16721FC CHROME, W/BLUE BOW TIE (PR)

ACCESSORY HOOD ORNAMENT

1947-52
47-16724FC CHROME



CENTRE HOOD STRIP MOLDINGS

1947-55
47-16725SS STAINLESS
STEEL

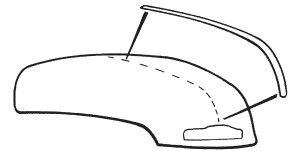

WIPER MOTORS

ELECTRIC WIPER MOTOR

CONVERSION KITS

- C/W TWO SPEED SWITCH

1947-53
47-17508PU12 REPLACES VACUUM UNIT
(12 VOLT)
1954-55 1st SERIES
54-17508PU12 REPLACES VACUUM UNIT
(12 VOLT)

1955-57
55-17508
1958-59
58-17508



WINDSHIELD WIPER ARMS

1947-53
47-17526 (RH) ORIGINAL STYLE
47-17527 (LH) ORIGINAL STYLE



47-17526NS (RH) SNAP IN
47-17527NS (LH) SNAP IN

1954-59
54-17526 (RH)
54-17527 (LH)



1960-66
60-17526 (RH)
60-17527 (LH)



1967-72
67-17526/7 LEFT OR RIGHT



WINDSHIELD WIPER BLADES
SOLD EACH

1947-53
BB-17528 ORIGINAL STYLE (8")
21A-17528 ORIGINAL STYLE (9")
10-17528 ORIGINAL STYLE (10")



47-17528 SNAP IN TYPE (10")

1954-55
54-17528 1st SERIES (11")
1955-59
55-17528 (12")



1960-66
60-17528 POLISHED STAINLESS



1967-72
67-17528 POLISHED STAINLESS

WIPER TRANSMISSION CLIP & SPRING ASSEMBLY

1947-53
47-17531
1954-59
54-17531 1st SERIES

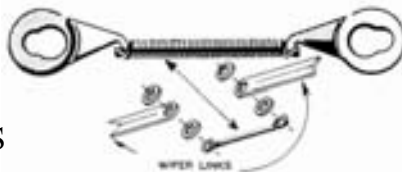

WIPER TOWER GASKET SETS

1947-53
47-17541
1954-55
54-17541 1st SERIES
1955-59
55-17541



WIPER TOWER BEZELS

1947-53
47-17552 CHROME (PR)



1955-59
55-17552 CHROME (PR)



1947-59
55-17553 HOLD DOWN NUTS -
STAINLESS STEEL (PR)



1955-59
55-17666 WASHER SPRAY NOZZELS -
CHROME (PR)



WIPER SWITCH RETAINING NUT

1955-59
55-17554 (EA)



WIPER SWITCH KNOBS

1947-53
47-17513C CHROME
47-17513M MAROON



1954-55 1st SERIES
54-17513B BLACK
54-17513G "GMC" GRAY



1955-59
55-17513 CHROME
(9/16" HOLE)



CHEVY PICKUP 1947 to 1972

www.oldcarcentre.com

1960-63
60-17513 BLACK &
STAINLESS STEEL



1964-66
64-17513 BLACK &
STAINLESS STEEL



1968-72
68-17514 BLACK & STAINLESS
STEEL



WIPER SWITCH

1960-63
60-17500 SINGLE SPEED WITH WASHER
1963
63-17500 2 SPEED WITH WASHER
1964-66
64-17500 2 SPEED WITH WASHER
1967 CHEVROLET & GMC
67-17500
1968-72
68-17500

HEATER

DELUXE HEATER CONTROL LEVERS

1955-59 CHEVROLET
55-17514 (PR)



1967-72 CHEVROLET & GMC
67-17524LK C/W KNOBS

DELUXE HEATER CONTROL KNOB SETS

1955-59
CA-612



1960-63
60-17515



1964-66
64-17515



DELUXE HEATER FAN SWITCH

1955-59 CHEVROLET
55-17516



1967-72 CHEVROLET & GMC
67-17524-SW HEATER/AC CONTROL UNIT
BLOWER SWITCH

DELUXE HEATER CONTROL

1955-59 CHEVROLET

55-17520 LENS



55-17521 METAL BACKING
PLATE



55-17525 BEZEL - CHROME



HEATER CONTROL UNIT WITH AC

1967-72 CHEVROLET & GMC
67-17525 UNIT WITH BLOWER SWITCH

DEFROSTER TOP VENT

1967-72 SOLD EACH
67-700590 L/H BLACK
67-700591 R/H BLACK
67-700590C L/H CHROME
67-700591C R/H CHROME



HEATER UNIT DECALS

1953
53-17512 STANDARD & DELUXE
(BLUE & RED ON SILVER)

1953-55
53-17512GMC "GMC" (RED ON SILVER)

1954-55 1ST SERIES
54-17512STD STANDARD (BLUE & RED ON
SILVER)

54-17512DLX DELUXE
(BLUE & RED ON SILVER)



AIR CONDITIONING COMPONENTS

GMC AIR CONDITIONING CONTROL BEZELS

1963-66
63-9330



CENTRE VENT

1967/72
67-700592 CHROME (EA)



A/C BALLS

CHROME W/BLACK PAINTED
DETAILS

1967-72
67-700593 (EA)



A/C BALL HOLDERS

1967-72
67-700594 (LH) BLACK W/FELT LINER
67-700595 (RH) BLACK W/FELT LINER
67-700594C (LH) CHROME W/FELT LINER
67-700595C (RH) CHROME W/FELT LINER



INTERIOR REAR-VIEW MIRRORS

INTERIOR MIRROR HEAD

1947-59
CB-363 POLISHED STAINLESS



1960-71
60-17681 POLISHED STAINLESS



INTERIOR DAY/NIGHT MIRROR

1947-53
47-17681DN CHROME



1954-59
54-17681DN CHROME



1960-64
60-17681DN STAINLESS
STEEL



1965-71
65-17681DN STAINLESS
STEEL



1972
72-17681DN STAINLESS
STEEL



INTERIOR MIRROR BRACKETS

1947-53
47-17690 STAINLESS STEEL



1954-55 1st SERIES
54-17690 CHROME



1955-59
55-17690 CHROME



1960-71 STANDARD
60-17690 CHROME



1969-71
69-17690 CHROME WITH
BLACK COVER



CHEVY PICKUP 1947 to 1972

www.oldcarcentre.com

INTERIOR MIRROR TO BRACKET SCREW

1960-72

58C-17690CS



OUTSIDE REAR-VIEW MIRRORS

1947-72 MIRROR HEADS - SOLD EACH

B-18403 ROUND HEAD
(5" RIBBED) BLACK



C-18403 ROUND HEAD
(5" RIBBED) CHROME



C-184030S ROUND HEAD
(5" SMOOTH)

R-18403 RECTANGULAR HEAD,
5 1/2 X 7 1/2,
STAINLESS STEEL



R-18403B RECTANGULAR HEAD,
5 1/2 X 7 1/2, BLACK

S-18403 STAINLESS STEEL, 5-5/8" HEAD

OUTSIDE MIRROR ASSEMBLY

INCLUDES: GASKET, MOUNTING
PLATE & SCREWS

1970-72

70-18403L L/H

70-18403R R/H



OUTSIDE MIRROR ARMS

SOLD EACH

1947-55 1st SERIES



47-17741LB BLACK (LH)

47-17741RB BLACK (RH)

47-17741LC CHROME (LH)

47-17741RC CHROME (RH)



1955-59

55-17741LB BLACK (LH)

55-17741RB BLACK (RH)

55-17741LC CHROME (LH)

55-17741RC CHROME (RH)



1960-66

60-17741LB BLACK (LH)

60-17741RB BLACK (RH)

60-17741LS STAINLESS
STEEL (LH)

60-17741RS STAINLESS
STEEL (RH)



1967-72

67-17741LB BLACK (LH)

67-17741RB BLACK (RH)

67-17741LS STAINLESS
STEEL (LH)

67-17741RS STAINLESS
STEEL (RH)



OUTSIDE MIRROR ARM GASKETS

SOLD EACH

47-17742 1947-55 1st SERIES



55-17742 1955-59



60-17742 1960-66 (RH)

60-17743 1960-66 (LH)



67-17742 1967-72



OUTSIDE MIRROR ARM MOUNTING SCREWS

1947-72



47-17745 STAINLESS STEEL - SET OF 3

INTERIOR PARTS

SUNVISOR PARTS

SUNVISOR PADS (EA)

- 1947-59
47-47380BK BLACK
47-47380BR BROWN
47-47380G GRAY
1960-66
60-47380BK BLACK
60-47380TN TAN
60-47380G GRAY
1967-72
67-47380BK BLACK



SUNVISOR BRACKETS (EA)

- 1947-53
47-47381 L/H
47-47382 R/H

1954-55 1st SERIES
54-47381 L/H
54-47382 R/H



- 1955-59
55-47381 L/H
55-47382 R/H



- 1960-66
60-47381 L/H
60-47382 R/H



- 1967-72
67-47381/2 L/H OR R/H



SUNVISOR HOOKS

- 1967-72
67-47382



HEADLINERS

CARDBOARD HEADLINERS

AVAILABLE IN BLACK, BROWN,
OR GRAY

- 1947-49
47-13784 SPECIFY COLOUR
1950-53
50-13784 SPECIFY COLOUR
1954-55 1st SERIES
54-13784 SPECIFY COLOUR

VINYL HEADLINERS

- 1955-59
55-13784 BLACK



HEADLINER PARTS

- 1947-54
47-13781SK HEADLINER SCREW KIT



- 1955-59
55-13785 1955 2nd SERIES &
1956-59 RETAINER
RUBBER



- 1967-72
67-13785C CHROME
HEADLINER
TRIM KIT

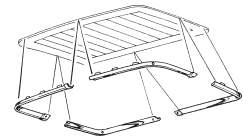

INTERIOR DOOR PANELS

- 1947-55 1st SERIES
47-56660BK BLACK (PR)
47-56660BR BROWN (PR)
47-56660G GRAY (PR)
1955-59
55-56660L LEFT HAND
55-56660R RIGHT HAND
1967-71
67-56660 (PR)
1972
72-56661 (PR) WOODGRAIN
1967-72
67-56662 (PR) CHROME UPPER DOOR PANEL
TRIM MOLDING



CHEVY PICKUP 1947 to 1972

www.oldcarcentre.com

INTERIOR DOOR PANEL FRAMES

W/UNION CLIP

1947-55

47-56661 1st SERIES (PR)

47-56661SS POLISHED STAINLESS (PR)



INTERIOR CAB SCREW KITS

1947-53

47-20010 (51 PCS)



DOOR PANEL SCREW SET

ENOUGH FOR TWO DOORS

1947-52

47-20015 (24 PCS)

1956-66

55-20015 (26 PCS)

1967-71

67-20015 (8 PCS)



FLOOR MATS

**FOR 2 WHEEL DRIVE 3 SPEED TRANSMISSION
(BLACK RUBBER)**

1947-54

47-700400

1955-59

55-700400

1960-63

60-700400

1964-66

64-700400

1967-72

67-700400

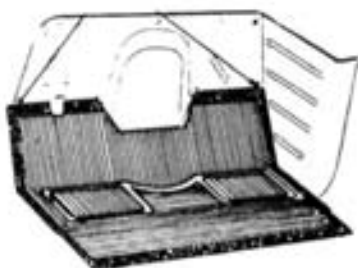

SEATBELT ASSEMBLIES

SOLD EACH - CHROME LIFT LATCH

VARIOUS COLOURS AVAILABLE

SB1



SEAT UPHOLSTERY KITS

1947-55 1st SERIES

47-SKBR BROWN

47-SKBK BLACK

47-SKM DARK MAROON

47-SKG GRAY

1955-59

55-SKG GRAY

55-SKBK BLACK

55-SKBE BEIGE

1960-66

60-UKFBK BLACK



CARDBOARD SEAT BACK

1947-55 1st SERIES

47-41550 BLACK -

W/FASTENERS



KICK PANELS

1947-55 1st SERIES

47-KPBK BLACK

47-KPBR BROWN

CARPET KITS

1947-55 1st SERIES

47-CKC GRAY

47-CKBK BLACK

47-CKBR BROWN

47-CKBU BURGUNDY

1955-59

55-CKC CHARCOAL

55-CKBK BLACK

1960-66

60-CKC CHARCOAL

60-CKBK BLACK

60-CKBR BROWN

1967-72

67-CK SPECIFY COLOUR



FIREWALL PAD



- 1947-55 1st SERIES
- B8-9007T CARDBOARD WITH INSULATION
- 1955-59
- 55-30741 MOLDED PLASTIC FOR UNDER DASH (WITH INSULATION)
- 55-30760 BLACK FIBERGLASS (NO HOLES DRILLED)
- 55-30090 FASTENERS (SET OF 10)

GLOVE BOX

INCLUDES RETAINER CLIPS

1947-49
47-43000



1950-53
50-43000

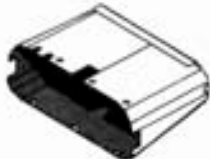

1954-55 1st SERIES
54-43000

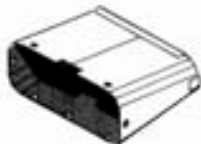

1955-59
55-43000

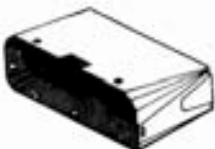

1960-63
60-43000



1964-66
64-43000
64-43000AC (W/AIR COND.)

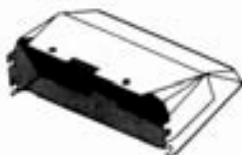

1967-72
67-43000
67-43000AC (W/AIR COND.)



GLOVE BOX DOOR

- 1947-53
- 47-43002B STAINLESS STEEL WITH PAINTED DETAILS
- 47-43002SS STAINLESS STEEL



- 1955-59
- 55-43002B WITH HINGE BRACKETS



- 1967-72
- 67-43002B BLACK
- 67-43002C CHROME



GLOVE BOX DOOR BUMPERS

- 1947-72
- 23-126 (EA)



GLOVE BOX DOOR HINGE

- 1967-72
- 67-43003SP C/W SPRING



GLOVE BOX LOCK

- 1947-53
- 47-43000CA INCLUDES TWO KEYS



- 1954-72
- 54-43000CA INCLUDES TWO KEYS



GLOVE BOX LOCK RETAINER

- 1947-53
- 47-43000R W/HARDWARE

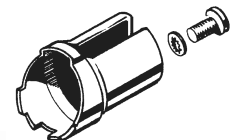

- 1954-72
- 54-43000R



CHEVY PICKUP 1947 to 1972

www.oldcarcentre.com

GLOVE BOX DOOR STRIKER

INCLUDES SCREWS

1954-59
54-43000S



1960-66
60-43000S



1967-72
67-43000S

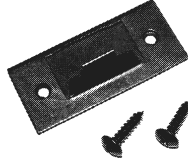

GLOVE BOX LAMP ASSEMBLY

1955-72
55-43001L



GLOVE BOX DOOR EMBLEMS

1964-66
64-43005 (GRAY W/BLACK LETTERS)
64-43005C (CHROME)

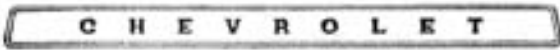

1967-68
67-43005



1969-72
69-43005CST "CUSTOM"



69-43005GMC "GMC CUSTOM"

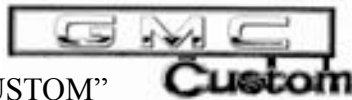

1969-70
69-43005BCST "CHEVROLET CST"



1967-72
67-43006W WOODGRAIN APPLIQUE FITS
STANDARD DOOR WITHOUT TRIM



1971-72
71-43006W WOODGRAIN APPLIQUE FITS
DELUXE DOOR WITH TRIM

ARM RESTS

SOLD EACH

1947-55 1st SERIES
47-56665BK BLACK
47-56665BR BROWN
47-56665G GRAY



1955-66
55-56665BK BLACK
55-56665BR BROWN
55-56665G GRAY

1964-67
64-56665G GRAY
64-56665BK BLACK



1967-71
67-56665BK BLACK
67-56665BL BLUE
67-56665G GREEN
67-56665P PARCHMENT
67-56665R RED
67-56665S SADDLE



1972
72-56665LBK (LH) BLACK
72-56665RBK (RH) BLACK
72-56665LBL (LH) BLUE
72-56665RBL (RH) BLUE
72-56665LG (LH) GREEN
72-56665RG (RH) GREEN
72-56665LP (LH) PARCHMENT
72-56665RP (RH) PARCHMENT
72-56665LR (LH) RED
72-56665RR (RH) RED
72-56665LS (LH) SADDLE
72-56665RS (RH) SADDLE
72-56665LGY (LH) GRAY
72-56665RGY (RH) GRAY



COWL VENT PARTS

COWL VENT KNOB

- 1947-53
47-700611 MAROON (EA)
1954-55
54-700611 1st SERIES BLACK (EA)



COWL VENT DRAIN HOSE

- 1947-55
47-700614 1st SERIES



SIDE COWL VENT SEALS

- 1947-50
47-700615 (EA)
1955-59
55-700615 (SET OF 2)
1960-66
60-700615 (SET OF 2)

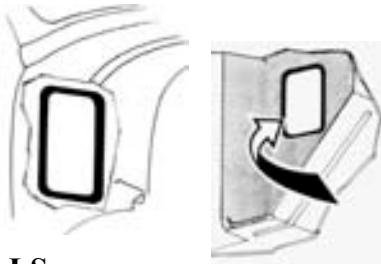

TOP COWL VENT SEALS

- 1947-53
47-700616
1954-55 1st SERIES
54-700616



SIDE VENT CONTROL ASSEMBLY

SOLD EACH

- 1955-59
55-700617B BLACK KNOB
FITS RIGHT OR LEFT
55-700617C CHROME KNOB
FITS RIGHT OR LEFT



- 1960-63
60-700617L BLACK & STAINLESS
KNOB L/H
60-700617R SAME AS ABOVE R/H



DOOR PARTS

DOOR SILL PLATES

- FITS RIGHT OR LEFT
- SOLD EACH
1960-66
60-705000CNL CHROME - NO LOGO
60-705000SSNL STAINLESS STEEL - NO LOGO
1960-66 GMC
60-705000GMC CHROME
1967-72
67-705000 CHROME
67-705000SS STAINLESS STEEL
67-705000C CHROME WITH BOWTIE EMBLEM
67-705000CSS STAINLESS STEEL WITH BOWTIE
EMBLEM



DOOR WEATHERSTRIP

- FITS ON DOOR
1947-55 1st SERIES
47-20530
1955-59
55-20530 WITH CLIPS
3M-80010 WEATHERSTRIP ADHESIVE



LOWER DOOR SEALS

- 1941-49
47-20520
1950-55 1st SERIES
50-20520T TAN
50-20520 BLACK

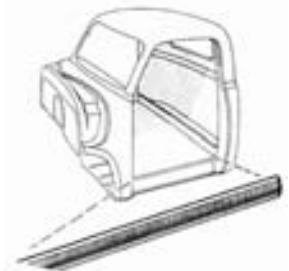

CAB WINDLACE

- RUBBER THAT FITS AROUND CAB ON BODY

- 1941-48
41-20525
1949-55 1st SERIES
47-20525 BLACK
47-20525T TAN
1960-61
60-20531
1962-66
62-20531
1967-72
67-20531



CHEVY PICKUP 1947 to 1972

www.oldcarcentre.com

DOOR CHECK RETAINER

1960-66
60-702828S (EA)



1967-72
67-46105 (LH)
67-46106 (RH)

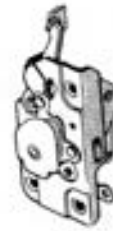

DOOR HINGE PIN

1947-59 1st SERIES
47-46335 (EA)
47-46335B HINGE BUSHING (PR)



REAR PANEL TRUCK DOOR LATCH

1955-59
55-46107

DOOR HINGE PIN & BUSHING REPAIR KIT

1955-72
55-46335S (PR)



DOOR LATCH SCREWS

1947-52
47-46105SK (4 PCS)
1952-59
52-46105SK (3 PCS)
1960-72
67-46105SK (12 PCS)



UPPER DOOR HINGE TENSION SPRINGS

1947-55 1st SERIES
47-702345 (PR)



DOOR STRIKERS

SOLD AS PAIRS

1947-51
47-702340



1952-59
52-702340

DOOR LATCHES

SOLD EACH

1947-51
47-46105 L/H
47-46106 R/H

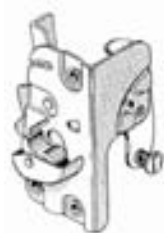

1952-55 1st SERIES
52-46105 L/H
52-46106 R/H

1955-59
55-46105 L/H
55-46106 R/H



1960-63
60-46105 (LH)
60-46106 (RH)

1964-66
64-46105 (LH)
64-46106 (RH)



DOOR STRIKER SCREWS

1947-51
47-702340SK 4 PCS SET (1 STRIKER)
1952-59
52-702340SK 16 PCS SET (2 STRIKERS)



DOOR RELAYS

SOLD EACH

1947-55 1st SERIES

47-702411 L/H

47-702412 R/H



1955-59

55-702411 L/H

55-702412 R/H

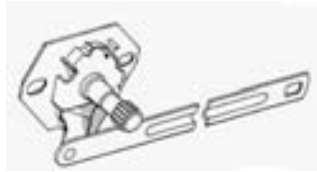

1960-63

60-702411 L/H

60-702412 R/H



1964-66

64-702411 L/H

64-702412 R/H



DOOR RELAY CONTROL

1967-71

67-702411 (LH)

67-702412 (RH)

1972

72-702411 (LH)

72-702412 (RH)

DOOR BUMPER SETS

ENOUGH FOR 2 DOORS

1947-51

47-46440



1952-55 1st SERIES

52-46440



1955-59

55-46440



1960-63

60-46440



1964-72

64-46440

DOOR HANDLES

INTERIOR DOOR HANDLE

SOLD EACH

1947-66

47-702400 W/SCREW

1967-72

67-702400 W/CLIP



EXTERIOR DOOR HANDLES

INCLUDES GASKETS

SOLD AS PAIRS

1947-51

47-702350/1



1952-59

52-702350/1 INCLUDES 1

NON-LOCKING

PUSH BUTTON



1960-66

60-702350/1 INCLUDES 1

NON-LOCKING

PUSH BUTTON



1967-72

67-702350/1



EXTERIOR DOOR HANDLE GASKET SET

1947-51

47-702356 (SET)

1952-66

52-702356 (SET)

1967-72

67-702356 (SET)



EXTERIOR DOOR HANDLE SCUFF PLATES

1952-59

52-702349 INCLUDES HARDWARE - PR

(HANDLES NOT INCLUDED)



CHEVY PICKUP 1947 to 1972

www.oldcarcentre.com

EXTERIOR DOOR LOCK CYLINDERS

INCLUDES TWO KEYS

1947-51
47-702350L (EA)



1952-55 1st SERIES
52-702350L (EA) 1-1/16" SHAFT LENGTH
1955-59
55-702350L (EA) 1-7/16" SHAFT LENGTH
1960-66
60-702350L (EA) 2-3/8" SHAFT LENGTH



1952-55 1st SERIES
52-702350LM MATCHING PAIR
1955-59
55-702350LM MATCHING PAIR
1960-66
60-702350LM MATCHING PAIR

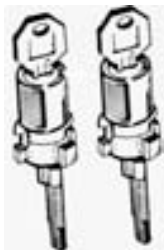

EXTERIOR DOOR LOCK SETS

COMPLETE LOCK SETS - DOOR LOCK, 1
IGNITION TUMBLER, 1 GLOVE BOX LOCK, 2
KEYS (KEYED ALIKE)

1947-51
47-702350SET (1 DOOR LOCK)
1952-53
52-702350SET (2 DOOR LOCKS)
1954-55 1st SERIES
54-702350SET (2 DOOR LOCKS)
1955-59
55-702350SET (2 DOOR LOCKS)
1960-66
60-702350SET (2 DOOR LOCKS)

DOOR LOCK PAWLS

SOLD EACH

1967-72
67-702302 L/H
67-702303 R/H

WINDOW REGULATORS

1947-50
47-48105 L/H
47-48106 R/H
1951-54
51-48105 L/H
51-48106 R/H
1955-59
55-48105 L/H
55-48106 R/H
1960-63
60-48105 L/H
60-48106 R/H
1964-66
64-48105 L/H
64-48106 R/H
1967/71
67-48105 L/H
67-48106 R/H
1972
72-48105 L/H
72-48106 R/H



WINDOW HANDLES

SOLD EACH

1947-66
47-702780 W/SCREW
1967-72
67-702780 W/CLIP



INTERIOR WINDOW & DOOR HANDLE CRANK ESCUTCHEON PLATE - PLASTIC

1967-72
CA-362



INSIDE DOOR HANDLE & WINDOW CRANK SHAFT GASKET SET

ENOUGH FOR TWO DOORS

1947-66
47-48139/8



WINDOW CHANNEL KITS

- INCLUDES FELTS, CHANNELS AND
HARDWARE

-COMPLETE FOR BOTH SIDES

1947-50
47-45983
1951-55 1st SERIES
51-45983
1955-59
55-45983



1960-63
60-45983A W/FRAMES AROUND GLASS
60-45983B W/FRAMELESS GLASS
1964-66
64-45983
1967-72
67-45983

CAT WHISKER ONLY

ZRC-3YM 8' LENGTH

SIDE WINDOW ANTI-RATTLE KIT

ENOUGH FOR BOTH SIDES

- INCLUDED IN WINDOW CHANNEL KIT

1947-50
47-45982
1951-55 1st SERIES
51-45982
1955-59
55-45982
1960-63
60-45982
1964-66
64-45982
1967-72
67-45982

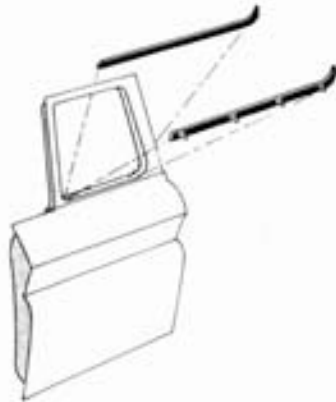

WINDOW DIVISION BAR W/FELTS

(NO HOLES OR BRACKETS)

SOLD EACH

1955-59
55-45984
1960-63
60-45984
1964-66
64-45984
1967-72
67-45984

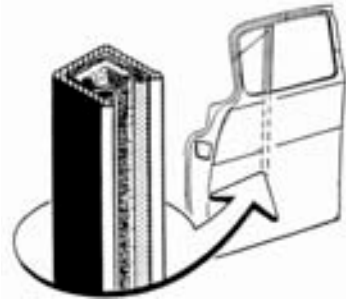

UPPER GLASS RUN CHANNEL

1964-66
64-45985
1967-72
67-45985

DOOR WINDOW SEAL

1955-59
55-45968 (2 REQUIRED) FITS IN GLASS
SETTING CHANNEL

VENT WINDOW PARTS

VENT WINDOW SEALS

DOES BOTH DOORS

1951-55 1st SERIES
51-7021448/9

1955-59
55-7021448/9

1960-63
60-7021448/9

1964-66
64-7021448/9

1967-72
67-7021448/9

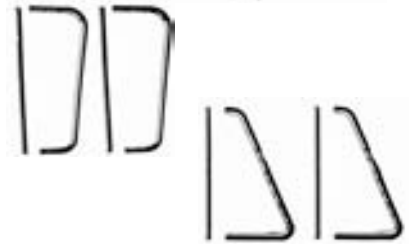

CHEVY PICKUP 1947 to 1972

www.oldcarcentre.com

VENT WINDOW FRAME

1951-55 1st SERIES CHEVROLET - GMC
51-7021440LVF (LH) BLACK FRAME C/W SEALS
51-7021440RVF (RH) BLACK FRAME C/W SEALS

1955-59
55-7021445 (LH) CHROME FRAME
55-7021446 (RH) CHROME FRAME

VENT WINDOW ASSEMBLY

1955-59
55-7021440L (LH) ASSY. WITH CHROME VENT WINDOW FRAME
55-7021440R (RH) ASSY. WITH CHROME VENT WINDOW FRAME

1968-72
68-7021440LC (LH) ASSY. C/W CLEAR GLASS
68-7021440RC (RH) ASSY. C/W CLEAR GLASS
68-7021440LT (LH) ASSY. C/W TINTED GLASS
68-7021440RT (RH) ASSY. C/W TINTED GLASS

VENT WINDOW HANDLES

INCLUDE WAFER WASHER AND ROLL PIN,
SOLD EACH

1951-55 1st SERIES
51-7022916 R/H
51-7022917 L/H



1955-59
55-7022916 R/H
55-7022917 L/H



1960-67
60-7022916 R/H
60-7022917 L/H



1968-72
68-7022916 R/H
68-7022917 L/H



WINDOW SEALS

WINDSHIELD SEALS

1947-53
47-79500S W/OUT GROOVE
FOR STAINLESS TRIM
47-79500D WITH GROOVE FOR
STAINLESS TRIM



1954-55 1st SERIES
54-79500S W/OUT GROOVE FOR
STAINLESS TRIM
54-79500D WITH GROOVE FOR
STAINLESS TRIM

1955-59
55-79500S W/OUT GROOVE FOR
STAINLESS TRIM
55-79500D WITH GROOVE FOR
STAINLESS TRIM



1960-63
60-79500S W/OUT GROOVE FOR
STAINLESS TRIM
60-79500D WITH GROOVE FOR
STAINLESS TRIM

1964-66
64-79500S W/OUT GROOVE FOR
STAINLESS TRIM
64-79500D WITH GROOVE FOR
STAINLESS TRIM



1967-72
67-79500S W/OUT GROOVE FOR
STAINLESS TRIM

1967-70
67-79500D WITH GROOVE FOR
STAINLESS TRIM

1971-72
71-79500D WITH GROOVE FOR
STAINLESS TRIM



FRONT WINDSHIELD CHROME TRIM

1947-53
47-79520
1955-59
55-79520
1967-70 PICKUP (6PC KIT)
67-79520
1971-72 PICKUP (6PC KIT)
71-79520

REAR WINDOW CHROME TRIM

1967-72 (6PC KIT)
67-704120

REAR WINDOW SEALS

1947-55 1st SERIES

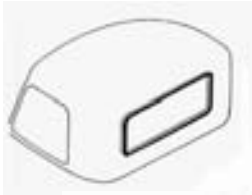

47-704220S STANDARD

47-704220D DELUXE (3 PCS)



1955-66



55-704220S STANDARD CAB

55-704220D DELUXE FOR WRAP
AROUND BACK WINDOW

1967

67-704220S STANDARD CAB

1968-72

68-704220S STANDARD SIZE W/O TRIM,
68-704220D C/W TRIM - DELUXE CAB

PANEL TRUCK REAR DOOR GLASS RUBBER CHANNEL

1955-59
55-30935

BUMPERS

FRONT BUMPERS

1947-55 PICKUP
47-17755 CHROME
47-17755SS POLISHED STAINLESS

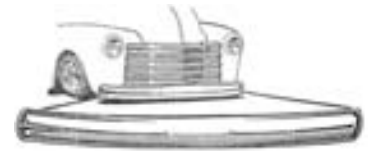

1955-59
55-17755 CHROME



1960-62
60-17755 CHROME
1963-66
63-17755 CHROME

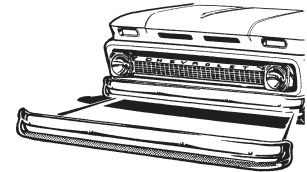

1967-70 CHEVROLET ONLY
67-17755

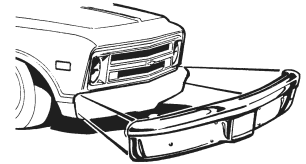

1971-72 CHEVROLET ONLY
71-17755



1967-72 GMC ONLY
67-17755GMC

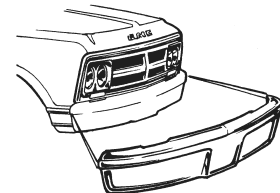

FRONT & REAR BUMPER GUARDS

1947-55 1st SERIES FRONT & REAR

47-17996 CHROME (PR)

1955-59 FRONT

55-17996 CHROME (PR)

1960-62 FRONT

60-17996 CHROME (PR)

1963-66 FRONT

63-17996 CHROME (PR)

1967-72 FRONT

67-17996 CHROME (PR)

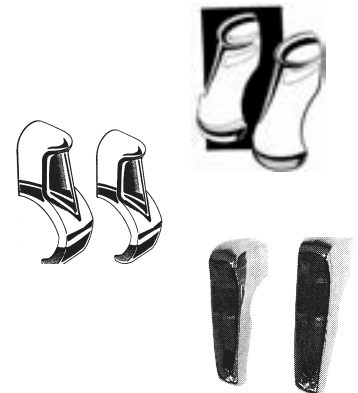

CHEVY PICKUP 1947 to 1972

www.oldcarcentre.com

FRONT BUMPER FILLER PLATE

1967-68
67-17740



FRONT BUMPER SPLASH APRON

1947-53 FITS CHEVROLET ONLY
47-17740B STAMPED STEEL
47-17740C CHROME
1954-55 1st SERIES
54-17740B
54-17740C CHROME
1967-68
67-17740

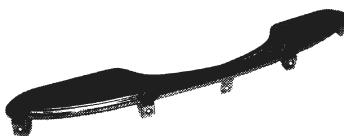

FRONT ROLL PAN

THIS PAN TAKES THE PLACE OF THE FRONT BUMPER FOR A SLICK SMOOTH LOOK
1967-72 FULL SIZE
67-100864

FRONT BUMPER BRACKETS

INCLUDES FRAME HARDWARE

1947-55
47-17780 (PR)

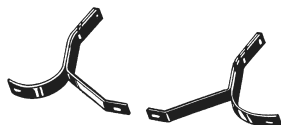

1955-57
55-17780 (SET)

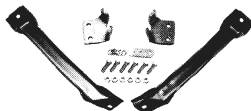

1958-59
58-17780 (SET)
1960-66
60-17788L (LH) OUTER
60-17788R (RH) OUTER
1967-70 CHEVROLET & 1967-72 GMC
67-17780 (SET)
1971-72 CHEVROLET
71-17780 (SET)

REAR BUMPERS

1947-53 STEPSIDE
47-17750 CHROME
47-17750SS POLISHED STAINLESS
1947-55 PANEL DELIVERY AND SUBURBAN
47-17755 CHROME
47-17755SS SAME AS ABOVE - POLISHED STAINLESS



1954-55 1ST SERIES STEPSIDE

54-17750 CHROME
1955-59 STEPSIDE
55-17750S CHROME
1958-59 FLEETSIDE
58-17750F CHROME
1960-62 FLEETSIDE



60-17750F CHROME WITHOUT LICENCE PLATE HOLES

60-17750FWH CHROME WITH LICENCE PLATE HOLES

1960-66 STEPSIDE
60-17750S CHROME
1963-66 FLEETSIDE
63-17750F CHROME
1967-72 STEPSIDE
67-17750S CHROME
1967-72 - FLEETSIDE
67-17750F CHROME

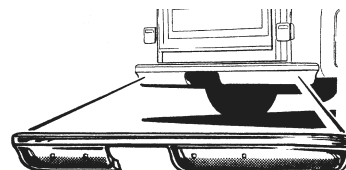

REAR BUMPER BRACKETS

WITH FRAME HARDWARE

1947-55 1st SERIES STEPSIDE
47-17787 SHORTBED - SET



1955-59
55-17787 STEPSIDE - SET



1958-59
58-17787F FLEETSIDE - SET
1960-62
60-17787 FLEETSIDE - SET



1963-66
63-17787 FLEETSIDE - SET
63-17787S STEPSIDE - SET

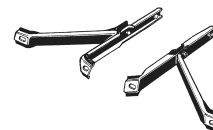

1967-72 FLEETSIDE OR STEPSIDE
67-17787 - SET

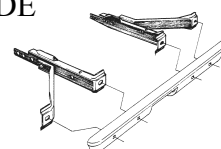

BUMPER BOLT WITH NUT

SOLD EACH

1947-72

47-17760 CHROME



REAR BUMPER LICENSE PLATE FILLER

PANEL

1967-72 STEPSIDE & FLEETSIDE

67-17765

REAR BUMPER GRAVEL SHIELD

1967-72 FLEETSIDE

67-17766 L/H

67-17767 R/H



REAR ROLL PAN - CHEVROLET OR GMC

THE REAR PAN TAKES THE PLACE OF THE BACK BUMPER FOR THE SMOOTH EFFECT.

- ALL ROLL PANS FEATURE LICENCE PLATE CUT-OUTS

1947-53 STEPSIDE

47-17749NL WITHOUT LICENCE PLATE LIGHTS

47-17749WL WITH LICENCE PLATE LIGHTS

1954-72 STEPSIDE

54-17749NL WITHOUT LICENCE PLATE LIGHTS

54-17749WL WITH LICENCE PLATE LIGHTS

1960-66 FLEETSIDE

60-17749NL WITHOUT LICENCE PLATE LIGHTS

60-17749WL WITH LICENCE PLATE LIGHTS

1967-72 FLEETSIDE

67-17749NL WITHOUT LICENCE PLATE LIGHTS

67-17749WL WITH LICENCE LIGHTS

RADIATOR SUPPORTS

RADIATOR SUPPORTS

1955-57

55-16020

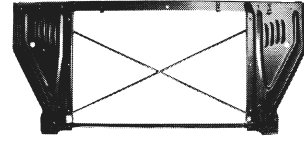

1958-89

58-16020

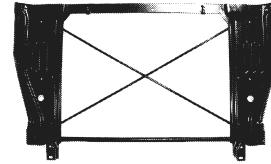

1960-66

60-16020

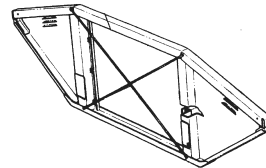

1967-68

67-16020

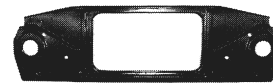

1969-72

69-16020



RADIATOR MOUNT PADS - SOLD IN PAIRS

1963-66

63-5000U 6CYL. OR V8 -
UPPER



63-5000L 6CYL OR V8 -
LOWER



1968-72

68-8285 UPPER OR LOWER
FOR 4 CORE RADIATOR



CHEVY PICKUP 1947 to 1972

www.oldcarcentre.com

SHEET METAL REPAIR

PANELS - 1947-55

1st SERIES



FLOORBOARD

1947-55

47-46060L LEFT - C/W
TOE BOARD



47-46060R RIGHT - C/W
TOE BOARD

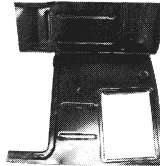

CAB MOUNT SUPPORTS - FRONT

1947-55

47-5002L LEFT
47-5002R RIGHT



CAB MOUNT SUPPORTS - REAR

1947-55

47-5003L LEFT
47-5003R RIGHT



ROCKER PANELS

1947-55

47-706000L LEFT
47-706000R RIGHT

REAR CAB PILLAR PATCH PANEL

1947-55

47-6000L LEFT
47-6000R RIGHT

CAB CORNERS - OUTER

1947-55

47-707000L LEFT
47-707000R RIGHT

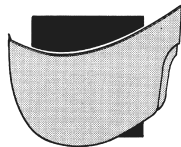

CAB CORNERS - INNER

1947-55

47-707500L LEFT
47-707500R RIGHT

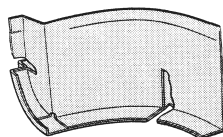

COWL PANEL

1947-55

47-16700L FULL OUTER PANEL -
LEFT (32" HIGH)



47-16700R FULL OUTER PANEL -
RIGHT (32" HIGH)

47-16700L2 LOWER OUTER PANEL
(21" HIGH) - LEFT



47-16700R2 LOWER OUTER PANEL
(21" HIGH) - RIGHT

47-12532LH INNER TO OUTER
BRACE - LEFT

47-12532RH INNER TO OUTER
BRACE - RIGHT



1947-50

47-12533LH INNER COWL PANEL
- LEFT

47-12533RH INNER COWL PANEL
- RIGHT

1951-55

51-12533LH INSIDE PANEL
- LEFT (23" HIGH)

51-12533RH INSIDE PANEL
- RIGHT (23" HIGH)

LOWER DOOR OUTER PATCH PANEL

1947-55

47-702355L LEFT - 12" HIGH
47-705355R RIGHT - 12" HIGH



INNER DOOR PATCH PANEL

1947-55

47-702354L LEFT - 5 1/2" HIGH
47-702354R RIGHT - 5 1/2" HIGH



EXHAUST HEAT SHIELD

1947-55

47-100734 STEEL
47-100734SS STAINLESS STEEL

SHEET METAL REPAIR PANELS - 1955-59



OUTSIDE VISOR ASSEMBLY
55-15000 STEEL ACCESSORY,
BOLTS ON ROOF
ABOVE WINDSHIELD

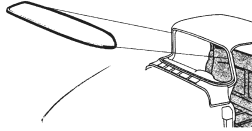

FLOOR BOARDS

55-46060L C/W TOE BOARD
- LEFT

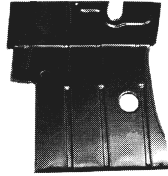

55-46060R C/W TOE BOARD
- RIGHT

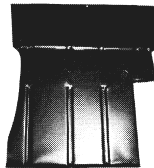

FRONT CAB MOUNT SUPPORT

55-5002L LEFT HAND
55-5002R RIGHT HAND



TRANSMISSION COVER

55-10000

INNER COWL KICK PLATE

55-46050L 19 1/2 X 17 1/2 LEFT HAND
55-46050R 19 1/2 X 17 1/2 RIGHT HAND

STEP PLATE REINFORCING BRACE
(ON UNDERSIDE OF STEP PLATE - 30" LONG)
55-30144

DOOR SILL STEP SUPPORT BRACKET

55-706020 LEFT OR RIGHT

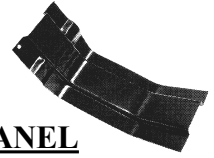

INSIDE STEP PLATE REPAIR PANEL

C-895-06L LEFT
C-895-06R RIGHT



ROCKER PANEL & STEP PLATE PANEL

(BOTH ROCKER & STEP PLATE ARE MADE AS
ONE REPAIR PANEL)

55-706010L LEFT
55-706010R RIGHT

ROCKER REPAIR PANEL

55-706000L LEFT
55-706000R RIGHT



OUTER REAR CAB CORNERS

55-707000L LEFT - PARTIAL
REPAIR PANEL
55-707000R RIGHT - PARTIAL
REPAIR PANEL



C-895-55AL LEFT - FULL REPAIR PANEL
C-895-55AR RIGHT - FULL REPAIR PANEL
C-895-55BL LEFT - INNER CAB CORNER
C-895-55BR RIGHT - INNER CAB CORNER

GRAVEL DEFLECTORS

55-30145 10" METAL SHIELD THAT
ATTACHES TO LOWER REAR
CAB CORNERS

LOWER DOOR HINGE REPAIR PANEL

55-46331L LEFT
55-46331R RIGHT



CHEVY PICKUP 1947 to 1972

www.oldcarcentre.com

LOWER OUTER DOOR HINGE PILLAR POCKET

55-46000L 9 1/2" X 7" - LEFT
55-46000R 9 1/2" X 7" - RIGHT

LOWER INNER DOOR HINGE PILLAR POCKET

55-46010L LEFT
55-46010R RIGHT

PARTIAL INNER DOOR BOTTOM

C-895-20L LEFT
C-895-20R RIGHT

FRONT FENDER REPAIR PANELS

1955-57
C-895-37L HEADLIGHT TOP PANEL - LEFT
C-895-37R HEADLIGHT TOP PANEL - RIGHT

C-895-35L REAR HALF OF FENDER - LEFT
C-895-35R REAR HALF OF FENDER - RIGHT

55-16005L LEFT - LOWER REAR FENDER
55-16005R RIGHT - LOWER REAR FENDER



1958-59
58-16005L LEFT - LOWER REAR FENDER
58-16005R RIGHT - LOWER REAR FENDER



FRONT FENDER REAR INNER BRACE

(THE BOLT TO ATTACH THE LOWER REAR FRONT FENDER SCREWS INTO THIS BRACE)

55-30146 LEFT - LOWER - 24"
55-30147 RIGHT - LOWER - 24"

EXHAUST HEAT SHIELD

47-100734 - STEEL
47-100734SS - STAINLESS STEEL



SHEET METAL REPAIR PANELS - 1960-66



ROCKER PANELS

60-706000L LEFT
60-706000R RIGHT



LOWER DOOR SKIN

C-896-12L LEFT 11" HIGH
C-896-12R RIGHT 11" HIGH



INNER DOOR BOTTOM

60-702354L LEFT
60-702354R RIGHT



FRONT FENDER REPAIR PANELS

C-896-34L FRONT SECTION (LH)
C-896-34R FRONT SECTION (RH)



C-896-35L REAR SECTION (LH)
C-896-35R REAR SECTION (RH)



60-16005L REAR LOWER SECTION (LH)

60-16005R REAR LOWER SECTION (RH)

FRONT CAB FLOOR SECTION

60-46060L LEFT
60-46060R RIGHT



REAR CAB FLOOR OUTER SECTION

C-896-45L LEFT
C-896-45R RIGHT



FRONT CAB SUPPORT

C-896-79L LEFT
C-896-79R RIGHT

REAR CAB SUPPORT

60-5003L LEFT
60-5003R RIGHT

BED FLOOR CROSS BRACE - U SHAPED

C-896-46B

CAB CORNER - P/U ONLY

60-707000L LEFT
60-707000R RIGHT



LOWER FRONT QUARTER PANEL

C-896-57L LEFT
C-896-57R RIGHT



LOWER REAR QUARTER PANEL

C-896-60L LEFT
C-896-60R RIGHT

WHEEL OPENING REPAIR PANEL

C-896-59L LEFT
C-896-59R RIGHT

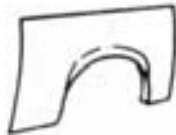

EXHAUST HEAT SHIELD

47-100734 - STEEL
47-100734SS - STAINLESS STEEL

**SHEET METAL REPAIR PANELS
1967-72**



ROCKER PANELS

67-706000L LEFT - OEM TYPE
67-706000R RIGHT - OEM TYPE



INNER ROCKER PANELS & BACKING PLATE

1960-67
67-706500L/R FITS LEFT
OR RIGHT



FULL DOOR SKINS

C-897-13L LEFT
C-897-13R RIGHT



LOWER DOOR SKINS

C-897-12L LEFT - 9" HIGH
C-897-12R RIGHT - 9" HIGH



FRONT DOOR LOWER PILLAR PATCH PANEL

67-702365L LEFT
67-702365R RIGHT

INNER DOOR BOTTOM

67-702354L LEFT
67-702354R RIGHT



FIREWALL / TOE PANEL

1967-68
67-46065
1969-72
69-46065



CHEVY PICKUP 1947 to 1972

www.oldcarcentre.com

FRONT FENDER PANEL

67-16005L REAR SECTION (LH)
67-16005R REAR SECTION (RH)



FOOTWELL

C-897-38L LEFT
C-897-38R RIGHT



CAB FLOOR PANEL

67-46060L LEFT
67-46060R RIGHT



67-706005L LEFT OUTER REAR
67-706005R RIGHT OUTER REAR

REAR CAB SUPPORT

60-5003L LEFT
60-5003R RIGHT



FRONT CAB FLOOR SUPPORT

67-5002

DOOR PILLAR

C-897-41L LEFT FRONT
C-897-41R RIGHT FRONT
C-897-41BL LEFT REAR
C-897-41BR RIGHT REAR



CAB CORNER

67-707000L LEFT
67-707000R RIGHT

REAR FENDER PANEL

C-897-53L LEFT - 8' BOX
C-897-53R RIGHT - 8' BOX

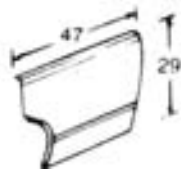

C-897-53AL LEFT - 6' BOX
C-897-53AR RIGHT - 6' BOX

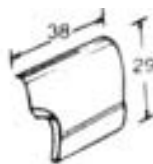

QUARTER PANEL - FRONT SECTION

C-897-56L LEFT - 8' BOX -
CUT DOWN FOR 6' BOX



C-897-56R RIGHT - 8' BOX -
CUT DOWN FOR 6' BOX

QUARTER PANEL - FRONT LOWER

C-897-57L LEFT - 8' BOX -
CUT DOWN FOR 6' BOX



C-897-57R RIGHT - 8' BOX -
CUT DOWN FOR 6' BOX

WHEEL OPENING PANEL

C-897-59L LEFT - 35" LONG
C-897-59R RIGHT - 35" LONG
C-897-59AL LEFT - 60" LONG
C-897-59AR RIGHT - 60" LONG



LOWER REAR FENDER PANEL

C-897-60L LEFT - 8' BOX -
CUT DOWN FOR 6' BOX
C-897-60R RIGHT - 8' BOX -
CUT DOWN FOR 6' BOX

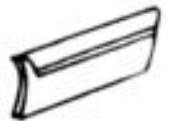

OUTRIGGER

C-897-79AL LEFT
C-897-79AR RIGHT



EXHAUST HEAT SHIELD

47-100734 STEEL
47-100734SS STAINLESS STEEL

FENDERS - FIBERGLASS

FRONT

1947-53
RFF-4753CPU RIGHT
LFF-4753CPU LEFT



REAR - STEPSIDE

1947-55 1st SERIES
RRF-4753CPU RIGHT
LRF-4753CPU LEFT



FENDERS - STEEL

FRONT FENDERS

1947-53
47-16000L L/H
47-16000R R/H
1954-55 1ST SERIES
54-16000L L/H
54-16000R R/H
1955-56
55-16000L L/H
55-16000R R/H
1957
57-16000L L/H
57-16000R R/H
1958-59
58-16000L L/H
58-16000R R/H
1960-66
60-16000L L/H
60-16000R R/H
1967 CHEVY & GMC
67-16000L L/H
67-16000R R/H
1968 CHEVY & 1968-72 GMC
68-16000L L/H
68-16000R R/H
1969-72 CHEVY ONLY
69-16000L L/H
69-16000R R/H



INNER FRONT FENDER PANELS

1947-54
47-16010L L/H
47-16010R R/H
1955-57
55-16010L L/H
55-16010R R/H
1958-59
58-16010L L/H
58-16010R R/H
1960-66
60-16010L L/H
60-16010R R/H
1967-72
67-16010L L/H
67-16010R R/H

REAR FENDERS - FITS BOTH LONG AND SHORTBEDS

1947-55 1st SERIES
47-16001L L/H
47-16001R R/H
1955-66
55-16001L L/H
55-16001R R/H
1968-72
68-16001L L/H
68-16001R R/H

REAR INNER FENDER PANELS

1967-72
67-16011L L/H
67-16011R R/H



CHEVY PICKUP 1947 to 1972

www.oldcarcentre.com

FENDER PARTS

FRONT END SHEET METAL HARDWARE KIT

1955-59

55-791 ALL NUTS BOLTS & WASHERS
TO ASSEMBLE FRONT END
SHEET METAL

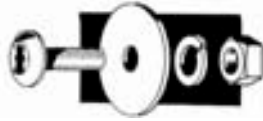

FRONT FENDER BOLT KIT

1947-55 1st SERIES

47-16050 INNER AND OUTER WITH WASHERS
- STAINLESS STEEL

REAR FENDER BOLT KIT - USING ORIGINAL STYLE CLUTCH HEAD BOLTS

1947-66 STEPSIDE

47-16026 STAINLESS STEEL

CLUTCH HEAD SCREW DRIVERS

CHSD-4 1947-UP (4 PCS)



FRONT FENDER GASKET SET

1947-55

47-16068

1955-59

55-16068

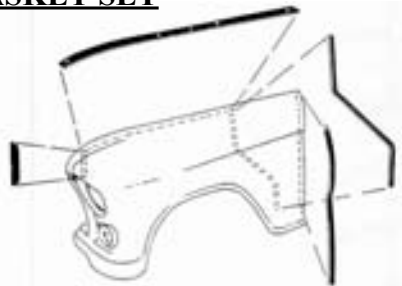

UNIVERSAL FENDER WELT

B-16070B BLACK (FT)

B-16070R RUBBER 25'

B-16070C STAINLESS STEEL
8 FT. LENGTHS

LOWER INNER FENDER ANTI-SQUEAK GROMMETS

1955-59

55-16188 (4 PCS)



RUNNING BOARDS - FIBERGLASS

* AVAILABLE RIBBED OR SMOOTH -
EXACT DUPLICATES OF NEW OLD STOCK
ORIGINAL BOARDS

1947-55 1/2 TON 1st SERIES

RB-4753PU SPECIFY STYLE

RUNNING BOARDS - STEEL



1947-54 & 1955 1st SERIES SHORTBED

47-16450/1 RIBBED - AS ORIGINAL

47-16450/1S SMOOTH

FRONT BED STEPS

1955-66

55-15000LSB L/H SHORTBED

55-15000RSB R/H SHORTBED

55-15000L L/H LONGBED

55-15000R R/H LONGBED

1967-72

67-15000LSB L/H SHORTBED

67-15000RSB R/H SHORTBED

RUNNING BOARD SPLASH APRONS

FORMED STEEL

1947-53 SHORTBED

47-16451LSB LEFT HAND

47-16451RSB RIGHT HAND

1954

54-16451LSB LEFT HAND

54-16451RSB RIGHT HAND

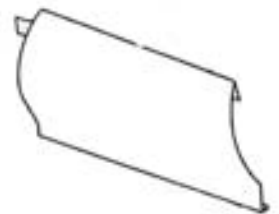

RUNNING BOARD SEALS

RUNNING BOARD TO REAR FENDER SEALS

1947-55
47-16460 (PR)



RUNNING BOARD TO BODY SEALS

1947-55 1st SERIES
47-16465
47-16465P PANEL TRUCK

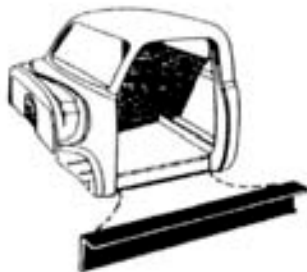

STEP PLATES

C-16400AS ALUMINUM
W/BOW TIE
EMBLEM
A-16400 STEP PLATE SCREW
KIT



DOORS

EXTERIOR DOOR SHELLS COMPLETE

1947-50
47-702360 LEFT HAND
47-702361 RIGHT HAND
1952-55 1st SERIES
52-702360 LEFT HAND
52-702361 RIGHT HAND
1955-59
55-702360 LEFT HAND
55-702361 RIGHT HAND
1960-63
60-702360 LEFT HAND
60-702361 RIGHT HAND
1964-66
64-702360 LEFT HAND
64-702361 RIGHT HAND
1967-71
67-702360 LEFT HAND
67-702361 RIGHT HAND
1972
72-702360 LEFT HAND
72-702361 RIGHT HAND

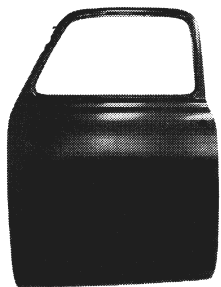

MOULDINGS

MOST MOULDINGS ARE ALSO AVAILABLE INDIVIDUALLY - PLEASE CALL FOR PRICING



COMPLETE BODY MOULDING SETS - INCLUDES CLIPS

1962-66 FLEETSIDE
62-80100SBK SHORT BED - CHEVROLET
62-80100SBKG SHORT BED - GMC
62-80100LBK LONG BED - CHEVROLET
62-80100LBKG LONG BED - GMC

LOWER BODY SETS

AVAILABLE WITH EITHER METAL PUSH IN AND SCREW ON CLIPS OR PLASTIC ADHESIVE AND METAL CLIPS - SPECIFY WHEN ORDERING

1969-72 FLEETSIDE

69-90100SBKB SHORT BOX - BLACK
69-90100SBKW SHORT BOX - WOOD GRAIN
69-90100LBKB LONG BOX - BLACK
69-90100LBKW LONG BOX - WOOD GRAIN
69-90100LHKB LONGHORN - BLACK
69-90100LHKW LONGHORN - WOOD GRAIN

UPPER BODY SIDE SETS

AVAILABLE WITH EITHER METAL PUSH IN AND SCREW ON CLIPS OR PLASTIC ADHESIVE AND METAL CLIPS - SPECIFY WHEN ORDERING

1969-72 FLEETSIDE

69-80100SBK SHORT BOX
69-80100LBK LONG BOX
69-80100LHK LONGHORN



CHEVY PICKUP 1947 to 1972

www.oldcarcentre.com

1955-59 (1955 2nd SERIES)

THIS TRIM FITS AROUND THE TWO SIDE WINDOWS, AND THE REAR WINDOW - CLIPS INCLUDED

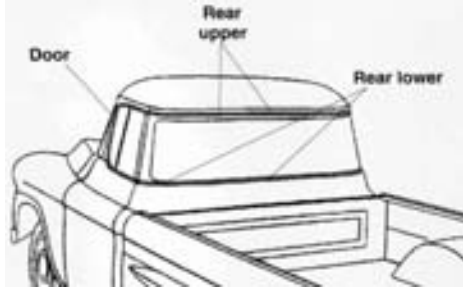

55-80000M CAB TRIM SET

1962-66 FLEETSIDE - CLIPS INCLUDED

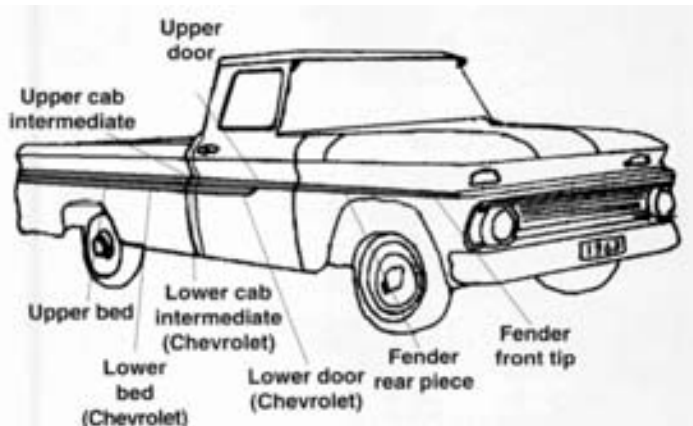

- 62-80015L LH - UPPER CAB
- 62-80015R RH - UPPER CAB
- 62-80015 LOWER CAB - LH OR RH
- 62-80000FF FRONT FENDER MOULDING POINT LH OR RH
- 62-80001 FRONT FENDER MOULDING-LH OR RH
- 62-80020SB SHORT BOX -UPPER BED -LH OR RH
- 62-80020LB LONG BOX - UPPER BED -LH OR RH
- 62-90020L LH - LOWER DOOR
- 62-90020R RH - LOWER DOOR
- 62-80010D UPPER DOOR - LH OR RH
- 62-90040SB SHORT BED- LOWER BED-LH OR RH
- 62-90040LB LONG BED -LOWER BED -LH OR RH

CUSTOM CAB MOULDINGS

SOLD IN PAIRS

- 1960-63
- 60-89000
- 1964-66
- 64-89000

FRONT FENDER EYEBROW MOLDINGS

- INCLUDES HARDWARE
- 1968 CHEVROLET
- 68-80000FFL LEFT HAND
- 68-80000FFR RIGHT HAND
- 1969-72 GMC
- 69-80000FFLGMC LEFT HAND
- 69-80000FFRGMC RIGHT HAND

DOOR EMBLEMS

FASTENERS INCLUDED (PAIRS)

- 1957
- 57-25621 "V"



Hydra-Matic

- 57-25622 "HYDRAMATIC"

- 1967-68
- 67-16723 "CUSTOM"



- 1968 TRUCK & 1969-72 BLAZER
- 68-16723 "CST"



FRONT FENDER EMBLEMS

FASTENERS INCLUDED (PAIRS)

- 1955
- 55-16721 CHEVROLET 3100 CHROME WITH WHITE PAINTED DETAILS
- 1955-56
- 55-25621 V8 WITH FASTENERS
- 1957
- 57-16721 CHEVROLET 3100 CHROME WITH RED PAINTED DETAILS
- 57-16721C CHEVROLET 3124 CHROME WITH RED PAINTED DETAILS



- 1962 CAMEO
- 62-16721 BOWTIE WITH "10"



- 1963
- 63-16721 BOWTIE WITH "10"



1964
64-16721 BOWTIE WITH "10"



1965
65-16721 BOWTIE WITH "10"



1966
66-16721 BOWTIE WITH "10"



1967-68
67-16721-10 BOWTIE WITH "10"
67-16721-20 BOWTIE WITH "20"



1969-70 "C/10"
69-16721-10
69-16721CST "CST/10"

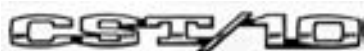

1969-72
69-16721C10 "CUSTOM/10"



69-16721C20 "CUSTOM/20"

69-16722-350 "8 350"



69-16722-396 "8 396"



69-16722-400 "8 400"



69-16722-454 "8 454"



1971-72
71-16721-10 "CHEYENNE/10"



71-16721-20 "CHEYENNE/20"



71-16721-30 "CHEYENNE/30"



71-16722DLX "DELUXE"



71-16722SPR "SUPER"

GMC FENDER EMBLEMS



1968-72
68-16721G158 GMC 1500 V-EIGHT
68-16721G258 GMC 2500 V-EIGHT

1972-72
71-16721G15C GMC 1500 CUSTOM
71-16721G25C GMC 2500 CUSTOM
71-16721G15SC GMC 1500 SUPER CUSTOM
71-16721G25SC GMC 2500 SUPER CUSTOM
71-16721G15S GMC 1500 SIERRA
71-16721G25S GMC 2500 SIERRA
71-16721G15SG GMC 1500 SIERRA GRANDE
71-16721G25SG GMC 2500 SIERRA GRANDE
71-16721GJ GMC JIMMY



CHEVY PICKUP 1947 to 1972

www.oldcarcentre.com

BOX PARTS

BED MOUNTING PAD SETS

1947-53

47-65005A 1/2 TON SHORTBED
(6 PCS)

47-65005B LONGBED & 1955-72
SHORTBED 1/2 TON (8 PCS)

1955-72

47-65005B SHORTBED 1/2 TON (8PCS)
55-65005 LONGBED 1/2 TON (10 PCS)



BED MOUNTING PAD & BLOCK SETS

1947-53

47-65005L LONGBED (14 PCS)
47-65005S SHORTBED (10 PCS)



TAILGATES

- 16 GAUGE STEEL



***NOTE: UNLESS OTHERWISE NOTED, CHAIN LATCHES ARE INCLUDED WITH TAILGATES**

1947-53 STEPSIDE

47-65050C CHEVROLET SCRIPT
47-65050GMC GMC SCRIPT
47-65050 SMOOTH

1954-72 STEPSIDE

54-65050C CHEVROLET SCRIPT
54-65050GMC GMC SCRIPT
54-65050 SMOOTH

1958-66 FLEETSIDE

58-65050 SMOOTH NO SCRIPT
58-65050C CHEVROLET SCRIPT
58-65050GMC GMC SCRIPT

1967-72 FLEETSIDE

67-65050 PLAIN - NO SCRIPT
67-65050C CHEVROLET SCRIPT
67-65050GMC GMC SCRIPT

TAILGATE DECALS

STEPSIDE - CHEVROLET

1947-53

47-65010B BLACK
47-65010C CHROME
47-65010W WHITE

1954-72

54-65010B BLACK
54-65010C CHROME
54-65010W WHITE

STEPSIDE "GMC"

1947-54

47-65012B BLACK
47-65012C CHROME
47-65012W WHITE

FLEETSIDE - CHEVROLET

1958-66

58-65011B BLACK
58-65011C CHROME
58-65011W WHITE

1967-72

67-65011B BLACK
67-65011C CHROME
67-65011W WHITE

TAILGATE BAND LETTERS

(W/FASTENERS) CHROME

1967-72

67-65014C CHEVROLET LETTERS

67-65014GMC GMC LETTERS

TAILGATE BANDS

COMPLETE WITH WOODGRAIN TAPE, CHROME LETTERS & FASTENERS

1967-72
67-65015C CHEVROLET



67-65015GMC GMC
67-65015CB CHEVROLET POLISHED ALUMINUM
WITH BLACK PAINTED INSERT



TAILGATE RELATED PARTS



TAILGATE HINGES

SOLD IN PAIRS

1941-53
47-65000
1967-72 FLEETSIDE
67-65051



TAILGATE TRUNNIONS

SOLD IN PAIRS

1954-72 STEPSIDE
54-65007

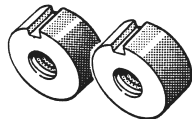

1958-66 FLEETSIDE
58-65007F

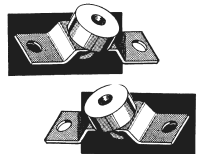

1967-72 FLEETSIDE
67-65007F

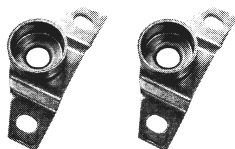

TAILGATE LATCH

1967-72
67-65052 (PR)

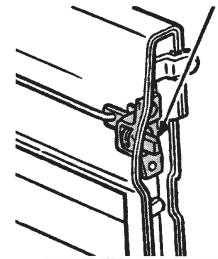

TAILGATE CHAINS

INCLUDES HARDWARE (PR)

1947-53 STEPSIDE
47-65006 CADMIUM PLATED
47-65006SS STAINLESS STEEL



1954-72 STEPSIDE
54-65006 CADMIUM PLATED
54-65006SS STAINLESS STEEL



1958-66 FLEETSIDE
58-65006 CADMIUM PLATED



TAILGATE CHAIN COVERS (PR)

1947-72 STEPSIDE
47-65009B BLACK
47-65009C CLEAR

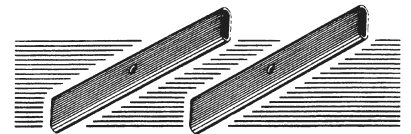

1958-66 FLEETSIDE
58-100672 GRAY
58-100671 BLACK
58-100673 CLEAR

TAILGATE ROD

1967-72 FLEETSIDE

67-65054 TAILGATE
LATCH ACTUATING
RODS FROM HANDLE (PR)

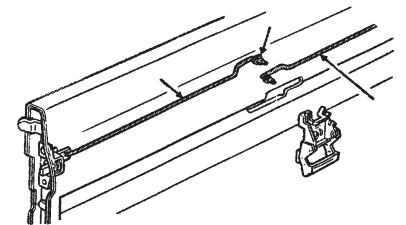

CHEVY PICKUP 1947 to 1972

www.oldcarcentre.com

TAILGATE HANDLE

1967-72 FLEETSIDE
67-65053

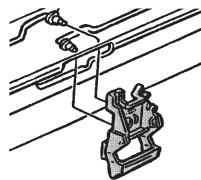

TAILGATE LATCH EYE BRACKETS

1958-66 FLEETSIDE
58-100670 (PR)



TAILGATE LATCH BAR COVER

1958-66 FLEETSIDE
58-100674 GREY (PR) FITS OVER CHAIN BAR

TAILGATE LATCH PIVOT BOLT

1958-66
58-65008 FLEETSIDE (PR)



TAILGATE ENDS

1947-53 STEPSIDE
47-100655 (PR)
1954-72 STEPSIDE
54-100656 (PR)

TAILGATE BUMPERS

FLEETSIDE
1967-72
D7-203T (PR)

TAILGATE MOULDINGS



UPPER TAILGATE MOULDINGS

1967-68 FLEETSIDE
67-95000UC CENTER
67-95000UL OUTER (LH)
67-95000UR OUTER (RH)

LOWER TAILGATE MOULDINGS

1967-72 FLEETSIDE
67-95000L

TAILGATE MOLDING CLIP KIT

1967-72
67-13447C 8PCS - UPPER OR LOWER

FRONT BED PANEL

NOTE: FRONT BED PANELS ARE ALSO AVAILABLE IN SMOOTH, LOUVERED, AND EMBOSSED BOWTIE. PLEASE CALL FOR CURRENT PRICING.

STEPSIDE

1947-53 C/W HARDWARE
47-65040
1954-59
54-65040S
1960-72
60-65040S



FLEETSIDE

1958-59
58-65040F
1960-66
60-65040F
1967-72
67-65040FS WITH STEEL FLOOR
67-65040FW WITH WOOD FLOOR

FRONT BED PANEL HARDWARE KITS

1954-72 STEPSIDE OR FLEETSIDE WITH WOOD FLOOR
54-65041SKZ ZINC
54-65041SKSS STAINLESS STEEL

1967-72 FLEETSIDE WITH STEEL FLOOR
67-65041SKZ ZINC
67-65041SKSS STAINLESS STEEL

BEDSIDES

COMPLETE WITH STAKE POCKETS, AND ANGLE STRIPS



SHORT STEPSIDE

HOLES ARE PREDRILLED FOR FENDERS, STAKE POCKETS, REAR CROSS SILL AND SQUARE HOLES IN ANGLE STRIPS

1947-53
47-16500L LEFT
47-16500R RIGHT
1954-55 1st SERIES - AVAILABLE IN PAIRS ONLY
54-102637 LEFT
54-102638 RIGHT
1955-59
55-102639 LEFT
55-102640 RIGHT
1960-66
60-102641 LEFT
60-102642 RIGHT
1967-72
67-102643 LEFT
67-102644 RIGHT

SHORT STEPSIDE

NO STAKE POCKET HOLES, WITH FENDER HOLES

1947-53
47-102734 LEFT
47-102735 RIGHT
1954-55 1st SERIES AVAILABLE IN PAIRS ONLY
54-102736 LEFT
54-102737 RIGHT
1955-59
55-102738 LEFT
55-102739 RIGHT
1960-66
60-102740 LEFT
60-102741 RIGHT
1967-72
67-102742 LEFT
67-102743 RIGHT

SHORT FLEETSIDE

1968-72 SHORT FLEETSIDE
68-16500SBL LEFT
68-16500SBR RIGHT

LONG STEPSIDE

NO FENDER HOLES

1947-53
47-110399 LEFT
47-110386 RIGHT
1954-55 1st SERIES AVAILABLE IN PAIRS ONLY
54-110400 LEFT
54-110387 RIGHT
1955-57 (89")
55-110401 LEFT
55-110388 RIGHT
1957-59 (97")
57-110402 LEFT
57-110389 RIGHT
1960-72
60-110403 LEFT
60-110390 RIGHT

BED HOLE CAPS

ALUMINUM CAP FOR THE HOLE IN THE END OF THE STEPSIDE BED SIDE - SOLD IN PAIRS



1947-66 WITH ORIGINAL BEDSIDES & 1947-72 WITH AFTERMARKET BEDSIDES LISTED ABOVE

47-102390 SATIN
47-102649 POLISHED
47-102750 SATIN BOWTIE
47-102752 POLISHED BOWTIE
1967-72 WITH ORIGINAL BEDSIDE
67-102489 SATIN
67-102651 POLISHED
67-102751 SATIN BOWTIE
67-102753 POLISHED BOWTIE



CHEVY PICKUP 1947 to 1972

www.oldcarcentre.com

STAKE POCKETS

1947-53 STEPSIDE

47-110407 FRONT - LEFT OR RIGHT

47-110413 REAR - LEFT

47-110410 REAR - RIGHT

1954-72 STEPSIDE

54-110408 FRONT - LEFT

54-110405 FRONT - RIGHT

54-110414 REAR - LEFT

54-110411 REAR - RIGHT



BED CROSS SILLS

- 14 GAUGE STEEL



STEPSIDE

1947-50

47-65030 CENTRE - 2 REQUIRED

47-65025 FRONT

47-65035 REAR - 1/2 TON

47-102628 REAR - 3/4 TON

1951-53

51-65030 CENTRE - 2 REQUIRED

51-65025 FRONT

51-65035 REAR - 1/2 TON

51-102618 REAR - 3/4 TON

1954-55 1ST SERIES

54-110426 CENTRE/FRONT - 3 REQUIRED

54-100713 REAR - 1/2 TON

54-100714 REAR - 3/4 TON

1955-59

55-110427 CENTRE/FRONT - 3 REQUIRED

55-100715 REAR

1960-62

60-110428 CENTRE/FRONT - 3 REQUIRED

60-100716 REAR

1963-72

63-110429 CENTRE/FRONT - 3 REQUIRED

1963-66

63-100717 REAR

1967-72

63-100718 REAR

FLEETSIDE

1958-59

58-110433 FRONT - 5 REQUIRED

58-100720 REAR

1960-62

60-110434 FRONT - 5 REQUIRED

60-100721 REAR

1963-72

63-110435 FRONT - 5 REQUIRED

63-100722 REAR

1967-72 WITH STEEL BED

67-65030S CENTRE

67-65035S REAR

1967-72 WITH WOOD BED

67-65030F CENTRE

REINFORCEMENT STRIPS

THESE STRIPS "REINFORCE" THE BED, BUT DO NOT ATTACH TO THE FRAME AS THE CROSS SILLS DO. THESE STEEL PIECES ARE PLACED PERPENDICULAR TO THE STRIPS AND WOOD FOR SUPPORT.

STEPSIDE

1955-59

55-110437

1960-72

60-110431

FLEETSIDE

1958-59

58-110437

1960-72

60-110438

1967-72 LONGHORN

67-110431



BED STRIP SETS

METAL BEDSTRIPS ARE ROLL FORMED AND PREPUNCHED WITH SQUARE HOLES ACCORDING TO THE ORIGINAL PATTERN

STEPSIDE - SHORTBOX

1947-50 8 PCS.

47-65001SBZ STEEL

47-65001SBSS POLISHED
STAINLESS

1951-53 7 PCS.

51-65001SBZ STEEL

51-65001SBSS POLISHED
STAINLESS

1954-59 7 PCS.

54-65001SBZ STEEL

54-65001SBSS POLISHED STAINLESS

1960-66 7 PCS.

60-65001SBSZ STEEL

60-65001SBSS POLISHED STAINLESS

1967-72 7 PCS.

67-65001SBSZ STEEL

67-65001SBSS POLISHED STAINLESS

STEPSIDE - LONGBOX

1947-50 8 PCS.

47-65001LBZ STEEL

47-65001LBSS POLISHED STAINLESS

1951-53 7 PCS.

51-65001LBZ STEEL

51-65001LBSS POLISHED STAINLESS

1954-55 1st SERIES 7 PCS.

54-65001LBZ STEEL

54-65001LBSS POLISHED STAINLESS

1955-57 89" 7 PCS.

55-65001LBZ STEEL

55-65001LBSS POLISHED STAINLESS

1957-59 97" 7 PCS.

57-65001LBSZ STEEL

57-65001LBSS POLISHED STAINLESS

1960-62 7 PCS.

60-65001LBSZ STEEL

60-65001LBSS POLISHED STAINLESS

1963-66 7 PCS.

63-65001LBSZ STEEL

63-65001LBSS POLISHED STAINLESS



1967-72 7 PCS.

67-65001LBSZ STEEL

67-65001LBSS POLISHED STAINLESS

FLEETSIDE - SHORTBOX

1958-59 15 PCS.

58-65001SBFZ STEEL

58-65001SBFSS POLISHED STAINLESS

1960-66 11 PCS.

60-65001SBFZ STEEL

60-65001SBFSS POLISHED STAINLESS

1967-72 11 PCS.

67-65001SBFZ STEEL

67-65001SBFSS POLISHED STAINLESS

FLEETSIDE - LONGBOX

1958-59 15 PCS.

58-65001LBFZ STEEL

58-65001LBFSS POLISHED STAINLESS

1960-62 11 PCS.

60-65001LBFZ STEEL

60-65001LBFSS POLISHED STAINLESS

1963-66 11 PCS.

63-65001LBFZ STEEL

63-65001LBFSS POLISHED STAINLESS

1967-72 11 PCS.

67-65001LBFZ STEEL

67-65001LBFSS POLISHED STAINLESS

BED SIDE ANGLE STRIPS

- ATTACH TO BOX SIDES - PAIRS

STEPSIDE - SHORTBOX

1947-53

47-65002SBZ STEEL

47-65002SBSS POLISHED
STAINLESS

1954-59

54-65002SBZ STEEL

54-65002SBSS POLISHED STAINLESS

1960-66

60-65002SBZ STEEL

60-65002SBSS POLISHED STAINLESS

1967-72

67-65002SBZ STEEL

67-65002SBSS POLISHED STAINLESS



CHEVY PICKUP 1947 to 1972

www.oldcarcentre.com

STEPSIDE - LONGBOX

1947-53
47-65002LBZ STEEL
47-65002LBSS POLISHED STAINLESS
1954-55 1st SERIES
54-65002LBZ STEEL
54-65002LBSS POLISHED STAINLESS
1955-57 (89")
55-65002LBZ STEEL
55-65002LBSS POLISHED STAINLESS
1957-59 (97")
57-65002LBZ STEEL
57-65002LBSS POLISHED STAINLESS
1960-62
60-65002LBZ STEEL
60-65002LBSS POLISHED STAINLESS
1963-66
63-65002LBZ STEEL
63-65002LBSS POLISHED STAINLESS
1967-72
67-65002LBZ STEEL
67-65002LBSS POLISHED STAINLESS

OAK BEDWOOD SETS WITHOUT HOLES

STEPSIDE - SHORTBOX

1947-50
47-110234
1951-53
51-110236
1954-59
54-110238
1960-72
60-110240



STEPSIDE - LONGBOX

1947-50
47-110248
1951-53
51-110250
1954-57 89"
54-110252
1957-59 97"
57-110254
1960-72
60-110256

FLEETSIDE - SHORT BOX

1958-59
58-110260
1960-72
60-110262

FLEETSIDE - LONG BOX

1958-59
58-110264
1960-72
60-110266

LONGHORN

1967-72 103"
67-110196

BED MOUNTING PADS

THESE PADS ARE PLACED BETWEEN THE REAR SILL BRACKET AND THE FRAME



1947-53
47-65005A ½ TON SHORTBED (6PCS)
47-65005B LONGBED & 1955-72
SHORTBED ½ TON (8PCS)
1955-72
47-65005B SHORTBED ½ TON (8PCS)
55-65005 LONGBED ½ TON (10 PCS)

BED MOUNTING BLOCKS

PRE-DRILLED BLOCKS USED AS SPACERS IN WOOD BEDS BETWEEN THE CROSS SILLS AND THE FRAME

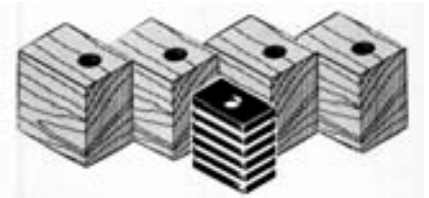

1947-53 STEPSIDE
47-65005S SHORT
47-65005L LONG

CADMIUM BED BOLT KITS

1947-50

47-65003C76 SHORT STEPSIDE
47-65003C85 LONG STEPSIDE - 85 7/8"

1951-53

51-65003C76 SHORT STEPSIDE
51-65003C85 LONG STEPSIDE - 85 7/8"

1954-55 1st SERIES

54-65003C77 SHORT STEPSIDE
54-65003C89 LONG STEPSIDE - 89"

1955-59

55-65003C77 SHORT STEPSIDE

1955-57

55-65003C89 LONG STEPSIDE - 89"

1957-59

57-65003C97 LONG STEPSIDE - 97"

1958-59

58-65003C77F SHORT FLEETSIDE
58-65003C97F LONG FLEETSIDE - 97"

1960-66

60-65003C77 SHORT STEPSIDE
60-65003C77F SHORT FLEETSIDE

1960-62

60-65003C97 LONG STEPSIDE - 97"
60-65003C97F LONG FLEETSIDE - 97"

1963-66

63-65003C97 LONG STEPSIDE - 97"
63-65003C97F LONG FLEETSIDE - 97"

1967-72

67-65003C97 LONG STEPSIDE - 97"
67-65003C77F SHORT FLEETSIDE
67-65003C97F LONG FLEETSIDE - 97"
67-65003C77 SHORT STEPSIDE

STAINLESS BED BOLT KITS

POLISHED STAINLESS STEEL

1947-50

47-65003SS76 SHORT STEPSIDE
47-65003SS85 LONG STEPSIDE - 85 7/8"

1951-53

51-65003SS76 SHORT STEPSIDE
51-65003SS85 LONG STEPSIDE - 85 7/8"

1954-55 1st SERIES

54-65003SS77 SHORT STEPSIDE
54-65003SS89 LONG STEPSIDE - 89"

1955-59

55-65003SS77 SHORT STEPSIDE

1955-57

55-65003SS89 LONG STEPSIDE - 89"

1957-59

57-65003SS97 LONG STEPSIDE - 97"

1958-59

58-65003SS77F SHORT FLEETSIDE
58-65003SS97F LONG FLEETSIDE - 97"

1960-66

60-65003SS77 SHORT STEPSIDE
60-65003SS77F SHORT FLEETSIDE

1960-62

60-65003SS97 LONG STEPSIDE - 97"
60-65003SS97F LONG FLEETSIDE - 97"

1963-66

63-65003SS97 LONG STEPSIDE - 97"
63-65003SS97F LONG FLEETSIDE - 97"

1967-72

67-65003SS97 LONG STEPSIDE - 97"
67-65003SS77F SHORT FLEETSIDE
67-65003SS97F LONG FLEETSIDE - 97"
67-65003SS77 SHORT STEPSIDE



CHEVY PICKUP 1947 to 1972

www.oldcarcentre.com

CUSTOM PARTS FOR YOUR CHEVY PICKUP

WE CARRY A COMPLETE LINE OF HOT ROD PARTS - SOME OF WHICH ARE LISTED BELOW -
PLEASE CALL WITH YOUR SPECIFIC REQUIREMENTS.

1947 - 1959 DISC BRAKE KITS

DISC BRAKE CONVERSION KIT

BASIC KIT - INCLUDES CALIPER MOUNTING BRACKETS, ATTACHING HARDWARE, AND BEARING ADAPTERS WHERE REQUIRED TO MOUNT TO STOCK SPINDLES

COMPLETE KIT - INCLUDES BASIC KIT PLUS NEW ROTORS, REBUILT CALIPERS WITH SEMI-METALLIC PADS AND MOUNTING BOLTS, NEW INNER AND OUTER BEARINGS AND SEALS

1947-55 FIRST SERIES
4658 BASIC KIT
4658C COMPLETE KIT
1955-59
4660 BASIC KIT
4660C COMPLETE KIT

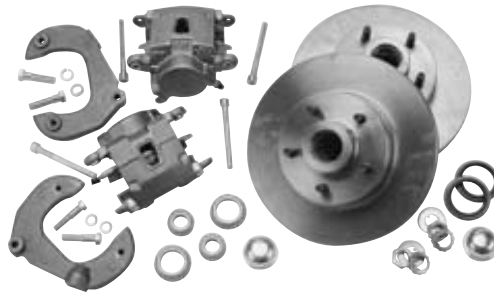

MASTER CYLINDER ADAPTER BRACKETS

ADAPTS 1967-72 MUSTANG OR 1967-76 CORVETTE TO THE STOCK BRAKE PEDAL IN THE STOCK LOCATION. SUPPLIED WITH PUSHROD, ROD END, HARDWARE AND NEW BOOT.

1947-55 FIRST SERIES
EC-420
1955-59
EC-425

POWER BRAKE BOOSTER/MASTER CYLINDER/PEDAL ASSEMBLY

THESE UNITS REPLACE THE STOCK BRAKE PEDAL AND FEATURE A NEW BOOSTER ASSEMBLED WITH A NEW 1976-82 CORVETTE 1" BORE 4 WHEEL DISC MASTER CYLINDER. THEY ARE PRESSURE AND VACUUM TESTED BEFORE BEING SHIPPED TO YOU. THEY CAN BE USED ON DISC/DRUM BRAKE COMBINATION BY INSTALLING OUR GM FACTORY PROPORTIONING VALVE WITH BUILT IN RESIDUAL PRESSURE VALVE FOR THE DRUM BRAKES OR WITH INLINE RESIDUAL CHECK VALVES.

1947-54
4847P
1955-59
4859P

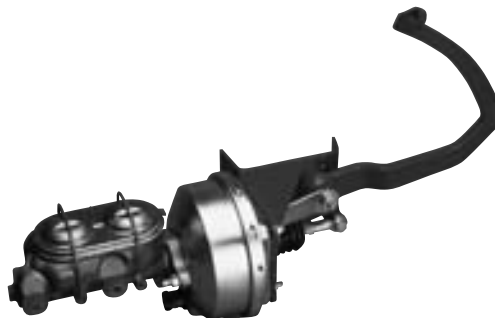

THE OLD CAR CENTRE Phone: 604-888-4412 Fax: 604-888-7455

#3 - 20075 92A Avenue, Langley, B.C. Canada V1M-3A5

POWER DISK BRAKE KITS 1960-1970

THESE KITS REQUIRE 15" OR LARGER WHEELS OR 14" DISC BRAKE WHEELS
- USE OF STOCK WHEELS REQUIRES BACK-SPACE OF AT LEAST 4-1/2"

YOU JUST CAN'T ENJOY DRIVING YOUR TRUCK WITHOUT RELIABLE DISC BRAKES. WITH OUR KITS, YOU'LL ONLY HAVE TO SUPPLY A FEW PIECES OF HARD BRAKE LINE TO TIE THE SYSTEM IN FROM THE SUPPLIED COMBINATION VALVE TO THE REST OF YOUR SYSTEM. THESE KITS ARE AVAILABLE IN STOCK HEIGHT OR 2-1/2" DROP SPINDLE CONFIGURATION, WITH OR WITHOUT POWER BOOSTER AND IN A FIVE OR SIX LUG PATTERN. 1/2 TON TRUCKS ONLY.

THESE COMPLETE DISC KITS INCLUDE ALL NEW: - 12" VENTED ROTORS - CALIPERS AND PADS - 8" DUAL DIAPHRAGM POWER BOOSTER AND MASTER CYLINDER - SPINDLES - COMBINATION VALVE KIT - HOSES AND HARDWARE - BEARINGS - SEALS - DUST CAPS.

1960-62 5 LUG

DB1754P POWER DISC KIT, STOCK HEIGHT
DB1754M MANUAL DISC KIT, STOCK HEIGHT
DB1754B BOTTOM KIT ONLY, STOCK HEIGHT
DB1754PD POWER DISC KIT, 2-1/2" DROP SPINDLE
DB1754MD MANUAL DISC KIT, 2-1/2" DROP SPINDLE
DB1754BD BOTTOM KIT ONLY, 2-1/2" DROP SPINDLE

1960-62 6 LUG

DB1754P6 POWER DISC KIT, STOCK HEIGHT
DB1754M6 MANUAL DISC KIT, STOCK HEIGHT
DB1754B6 BOTTOM KIT ONLY, STOCK HEIGHT
DB1754PD6 POWER DISC KIT, 2-1/2" DROP SPINDLE
DB1754MD6 MANUAL DISC KIT, 2-1/2" DROP SPINDLE
DB1754BD6 BOTTOM KIT ONLY, 2-1/2" DROP SPINDLE

1963-70 5 LUG

DB1755P POWER DISC KIT, STOCK HEIGHT
DB1755M MANUAL DISC KIT, STOCK HEIGHT
DB1755B BOTTOM KIT ONLY, STOCK HEIGHT
DB1755PD POWER DISC KIT, 2-1/2" DROP SPINDLE
DB1755MD MANUAL DISC KIT, 2-1/2" DROP SPINDLE
DB1755BD BOTTOM KIT ONLY, 2-1/2" DROP SPINDLE

1963-70 6 LUG

DB1755P6 POWER DISC KIT, STOCK HEIGHT
DB1755M6 MANUAL DISC KIT, STOCK HEIGHT
DB1755B6 BOTTOM KIT ONLY, STOCK HEIGHT
DB1755PD6 POWER DISC KIT, 2-1/2" DROP SPINDLE
DB1755MD6 MANUAL DISC KIT, 2-1/2" DROP SPINDLE
DB1755BD6 BOTTOM KIT ONLY, 2-1/2" DROP SPINDLE



CHEVY PICKUP 1947 to 1972

www.oldcarcentre.com

POWER BRAKE CONVERSION KITS

REPLACE YOUR OLD POWER BOOSTER OR ADD POWER BRAKES WITH ONE OF OUR EASY BOLT-ON 9" POWER BOOSTERS WITH A MASTER CYLINDER. THESE KITS BOLT DIRECTLY TO THE FIREWALL AND COME WITH THE CORRECT LINKAGE.

1960-62

BM1753 AUTOMATIC TRANSMISSION

BM1750 MANUAL TRANSMISSION WITH HYDRAULIC CLUTCH

1963-72

BM1754

PROPORTIONING VALVES

4917 G.M. PROPORTIONING VALVE - DISC / DRUM

4854 ADJUSTABLE PROPORTIONING VALVE



RESIDUAL VALVE

4856A 2LB - IS USED ON DISC BRAKE SYSTEMS

4856B 10LB - TO HOLD LINE PRESSURE ON REAR BRAKE DRUM



"THE ONE AND ONLY" STEEL MONO LEAF SPRINGS

MEET OR EXCEED MULTI-LEAF SPECS AND PROVIDE SUPERIOR RIDE AND HANDLING - U-BOLTS INCLUDED - PLEASE SPECIFY STOCK OR REVERSED EYE - SOLD IN PAIRS

1947-55 FIRST SERIES

4754CTF FRONT

4754CTR REAR

1955-59

5559CTF FRONT

5559CTR REAR



MUSTANG II INDEPENDENT FRONT SUSPENSION

CROSSMEMBER KITS

- WELD IN

1947-55 FIRST SERIES

2302

1955-59

2033



THE OLD CAR CENTRE Phone: 604-888-4412 Fax: 604-888-7455

#3 - 20075 92A Avenue, Langley, B.C. Canada V1M-3A5

COMPLETE HUB TO HUB MUSTANG II KIT

INCLUDES CROSSMEMBER, TUBULAR UPPER & LOWER "A" ARMS, 2" DROPPED SPINDLES, 11" BRAKES, RACK, SHOCKS AND SPRINGS

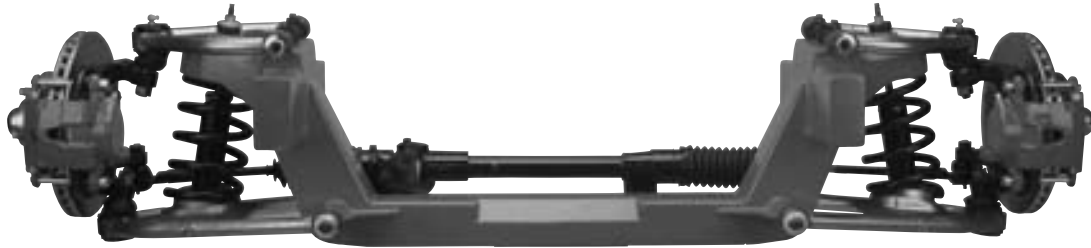

2935

2935P SAME AS ABOVE BUT WITH POWER RACK



4420 SAME KIT AS ABOVE BUT WITH AIR BAGS INSTEAD OF COILSPRINGS

INDEPENDENT FRONT SUSPENSION

CUSTOM DESIGNED FOR YOUR TRUCK. COMPLETE WITH ANTI ROLL BAR, 11" BRAKES, BOXING PLATES AND ALL HARDWARE
- NOTHING ELSE TO BUY. PLEASE CALL FOR CURRENT PRICING

1947-54

2120

1955-59

2121



CHEVY PICKUP 1947 to 1972

www.oldcarcentre.com

NEW MUSTANG II ROTORS AND BEARING KITS

WE OFFER NEW ROTORS WITH A 5 LUG CHEVY OR FORD BOLT PATTERN. THESE ARE NEW ROTORS THAT HAVE NOT BEEN PLUGGED AND REDRILLED TO ACHIEVE A 5 LUG BOLT PATTERN. WE ALSO OFFER A NEW SET OF FRONT WHEEL BEARINGS AND SEALS FOR THESE ROTORS - SOLD IN PAIRS

- 2035 FORD BOLT PATTERN
- 2036 CHEV BOLT PATTERN
- 2037 BEARING AND SEAL KIT - DOES BOTH SIDES



TCI MUSTANG II DISC BRAKE KIT

AVAILABLE WITH 1" VENTED ROTORS WITH 5 STUD CHEVROLET OR FORD BOLT CIRCLES, COMPLETE WITH CALIPERS AND CAST CALIPER BRACKETS, ROTORS, BEARINGS, SEALS AND HARDWARE.

- 4210 COMPLETE KIT - SPECIFY BOLT PATTERN
- 4214 CAST BRACKET KIT ONLY - SPECIFY BOLT PATTERN

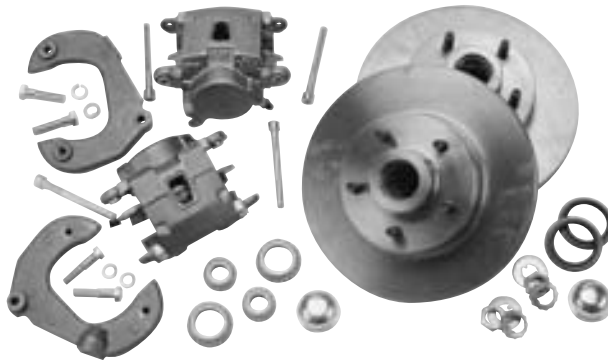

MUSTANG II UPPER A-ARMS

WE OFFER STOCK RECONDITIONED AND TUBULAR UPPER A-ARMS FOR MUSTANG II FRONT ENDS.

COMPLETE UNITS FEATURE NEW BALL JOINTS, BUSHINGS AND HARDWARE. TUBULAR ARMS COME GOLD IRRIDATED AND ARE AVAILABLE IN POLISHED STAINLESS

- 2034 TUBULAR UPPER A-ARMS
- 2034ST STOCK UPPER A-ARMS



MUSTANG II LOWER A-ARMS

WE OFFER STOCK RECONDITIONED AND TUBULAR LOWER A-ARMS FOR MUSTANG II FRONT ENDS.

COMPLETE UNITS FEATURE NEW BALL JOINTS, BUSHINGS AND HARDWARE. TUBULAR ARM ELIMINATES NEED FOR STRUT ROD. TUBULAR ARMS COME GOLD IRRIDATED AND ARE AVAILABLE IN POLISHED STAINLESS

2036A TUBULAR LOWER A-ARMS
2036ST STOCK LOWER A-ARMS



AIR SPRING RETRO-FIT KIT FOR MUSTANG II

INCLUDES AIRBAGS, TUBULAR LOWER CONTROL ARMS, SHOCKS, BRACKETS AND ALL HARDWARE

4410



COMPLETE FRONT AND REAR AIR RIDE SYSTEMS ARE AVAILABLE

FOR ALL MAKES & MODELS - PLEASE CALL WITH YOUR SPECIFIC APPLICATION

MUSTANG II 2" DROPPED SPINDLES

WE OFFER A NEW 2" DROPPED SPINDLE FOR MUSTANG II FRONT ENDS. UNITS RETAIN FACTORY GEOMETRY AND ACCEPT STOCK COMPONENTS.

2700M 2" DROP SPINDLES



* WE ALSO OFFER MANY OTHER PARTS FOR THE MUSTANG II I.F.S. FRONT END ALONG WITH U-JOINTS AND SHAFTS TO CONNECT YOUR STEERING.

PLEASE FEEL FREE TO CALL OR WRITE FOR PRICING AND AVAILABILITY ON AFTERMARKET PARTS NOT LISTED.



CHEVY PICKUP 1947 to 1972

www.oldcarcentre.com

REAR PARALLEL LEAF SPRING KIT

TCI - KITS INCLUDE SPRINGS, SHOCKS, U-BOLTS, LOWER PLATES, AXLE PADS, SHACKLES AND FRAME BRACKETS

1947-54
2359
1955-59
2362

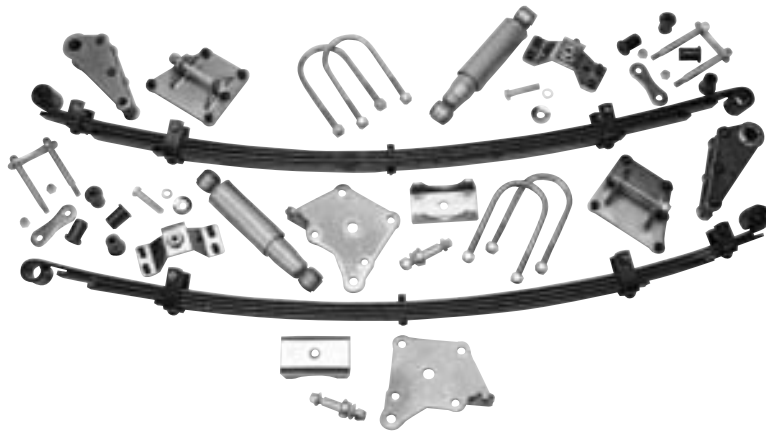

REAR PARALLEL LINK KIT

NOW YOU CAN EASILY INSTALL A TRICK COIL-OVER/4LINK REAR SUSPENSION KIT UNDER YOUR CHEV PICKUP.

T.C.I. ENGINEERING'S FULLY ADJUSTABLE 4-LINK KIT COMES COMPLETE WITH 1" X .156 WALL SEAMLESS BARS, 3/4" STAINLESS ONE-PIECE ADJUSTORS, URETHANE BUSHINGS, FRAME BRACKETS, 3-POSITION COIL-OVER AXLE BRACKETS, NEW REAR FRAME CROSSMEMBER, ALL-AMERICAN COIL-OVER SHOCKS, PANARD BAR AND BRACKETS, ALL HARDWARE AND INSTRUCTIONS. PRACTICALLY A TOTAL BOLT-IN, THIS KIT IS SIMPLE TO INSTALL. DESIGNED TO UTILIZE THE EVER POPULAR FORD REAR END.

1947-54
3054 PLAIN
3054C CHROME
3054S POLISHED STAINLESS
1955-59
3059 PLAIN
3059C CHROME
3059S POLISHED STAINLESS

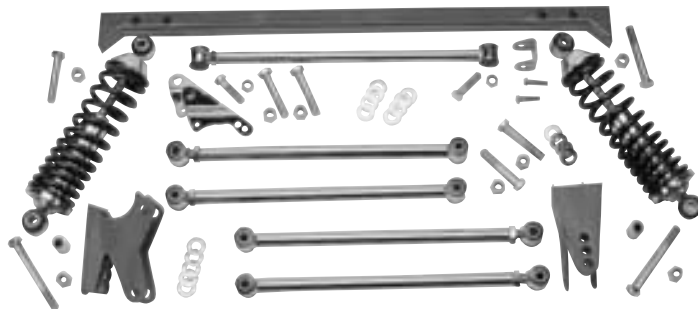

REAR AIRBAG SUSPENSION

AVAILABLE FOR BOTH PARALLEL REAR LEAF SPRINGS AND REAR 4 LINK SUSPENSION SETUPS

- CALL WITH YOUR SPECIFIC APPLICATION



THE OLD CAR CENTRE Phone: 604-888-4412 Fax: 604-888-7455

#3 - 20075 92A Avenue, Langley, B.C. Canada V1M-3A5

COIL-OVER SHOCKS

3000 COIL-OVER SHOCKS WITH SPRINGS - SOLD IN PAIRS

3000C SAME AS ABOVE ONLY SHOCKS ARE CHROME
WITH BLACK POWDER COATED SPRINGS

3654 ALDAN COILOVERS WITH ADJUSTABLE 6 POSITION
DAMPNING VALVE



MOTOR MOUNT CONVERSION KIT

BOLT-IN CROSSMEMBER KIT TO ADAPT
SMALL BLOCK CHEVY

1947-59

47-5019 TUBULAR CROSSMEMBER

1955-59

6626 WELD IN SIDE MOTOR MOUNT BRACKETS

6650 RUBBER MOUNTS FOR ABOVE

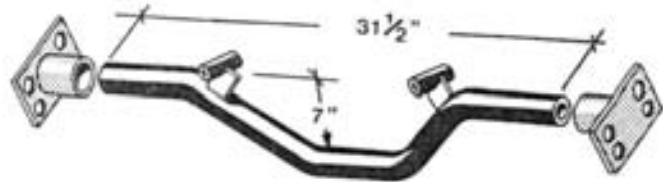

TRANSMISSION MOUNT

THIS CROSSMEMBER MOUNTS MOST ALL
STANDARD AND AUTOMATIC TRANSMISSIONS.

UNIVERSAL TUBULAR CROSSMEMBER

1947-59

47-5025

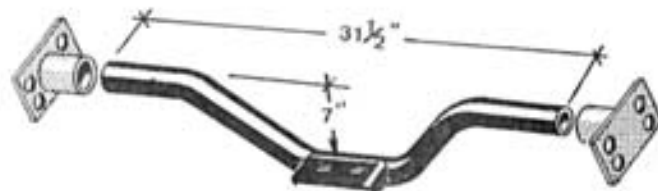

BOLT IN TUBULAR CROSSMEMBER C/W
MOUNTING HARDWARE

1947-54

6747

1955-59

6704



RUBBER/STEEL TRANSMISSION MOUNT PAD
FOR CHEV - SPECIFY T-350, T-400 OR 700R

1955-59

6660



CHEVY PICKUP 1947 to 1972

www.oldcarcentre.com

WALKER RADIATORS

CUSTOM BOLT-IN HEAVY DUTY RAD INCLUDES BUILT-IN AUTOMATIC TRANSMISSION COOLER.

WITH THE MANY YEARS AND MODELS TO CHOOSE FROM PLEASE CALL FOR PRICING AND AVAILABILITY. ALSO AVAILABLE WITH AIR CONDITIONING CONDENSOR BUILT ON.

5004W



UNIVERSAL POLY FUEL TANKS

22x17x9.5, 14 GALLON CAPACITY, ROLLOVER VENT VALVE, UNIVERSAL MOUNTING STRAPS, TOP-MOUNTED PICKUP TUBE BOLT-ON STEEL NECK, BILLET CAP WITH O-RING SEAL, ACCEPTS ALL POPULAR 5-HOLE SENDERS (SENDER NOT INCLUDED)

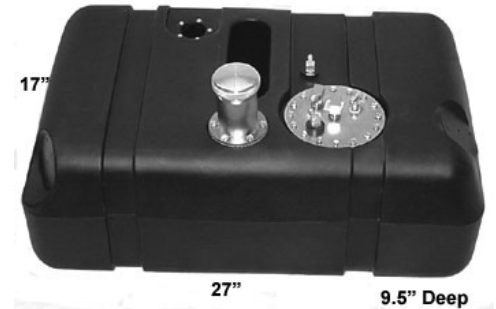

UT 3" TALL NECK

UT-H 2" OD X 2" TALL NECK WITH CONNECTING HOSE

FLUSH-MOUNT STAINLESS BOWL

6" OD WITH 4"OD X 1 3/8" DISH, 2 3/8" HOLE

FIM-2H STAINLESS WITH 2 3/8" HOLE

GR4 UNIVERSAL GROMMET FITS 2" - 2 1/2" BUNGS



COOL CAP



MANUFACTURED FROM 316 STAINLESS STEEL AND POLISHED TO A BRIGHT MIRROR FINISH. THE 3" DIAMETER IS ONLY ".080" THICK AND CAN BE EASILY RECESSED IF DESIRED. THE FLUSH CAP IS ACTUATED WITH A STAINLESS INTERFACE KEY THAT WILL UNSCREW THE CAP FROM ITS O-RING SEAL. A STAINLESS CHAIN PREVENTS LEAVING OR LOSING THE GAS CAP AFTER FILLING UP YOUR TANK. EASY TO INSTALL AND EASY ON THE EYES, THE COOLCAP IS THE PERFECT FINISHING TOUCH ON YOUR RIDE. COOLCAP COMES WITH ALL MOUNTING HARDWARE AND INSTRUCTIONS FOR EASY INSTALLATION.

CC001



THE OLD CAR CENTRE Phone: 604-888-4412 Fax: 604-888-7455

#3 - 20075 92A Avenue, Langley, B.C. Canada V1M-3A5

STAINLESS STEEL FUEL TANKS

1947-53 SUBURBAN, 1/2 TON PANEL & 1947-48 PICKUP
419-1080SR STOCK CAPACITY

1947-54
419-1082SR UNDER BED, LOCATED BEHIND REAR AXLE.
SPARE TIRE MOUNT MUST BE ELIMINATED

1955-59
419-109SR SAME AS ABOVE

DAKOTA DIGITAL DASHES

DASHES ARE AVAILABLE FOR 1947-72 PICKUPS IN VARIOUS COLOURS.
DIFFERENT OPTIONS ARE AVAILABLE, PLEASE CALL FOR PRICING



CLASSIC INSTRUMENTS

5" ROUND ELECTRIC SPEEDOMETER AND 4 GAUGE CLUSTER C/W BRACKETS TO FIT INTO YOUR ORIGINAL DASH BEZELS, C/W ALL SENDERS. AVAILABLE WITH EITHER A WHITE, GRAY, BLACK OR BEIGE FACE

1947-53 CHEVROLET
CW52 WHITE FACE
TR52 BLACK FACE
UT52 TAN FACE
SG52 GRAY FACE



CHEVY PICKUP 1947 to 1972

www.oldcarcentre.com

BRIZ BUMPERS

BRIZ POLISHED ALUMINUM 3-RIB BUMPERS
ONLY 2 7/8" WIDE FOR THE HIGH-TECH LOOK

7004

BRIZ POLISHED ALUMINUM 5-RIB BUMPERS 4 1/2" WIDE
FOR THE HEAVYWEIGHT LOOK

7006

BUMPER BOLTS FOR ABOVE BUMPERS

7008



BITCHIN PRODUCTS FOR YOUR 1947-55 TRUCK



FIREWALL

DESIGNED WITH ROUNDED BENDS.

HAS A FRONTAL OPENING OF 41", WITH A SET BACK OF 3",
MORE THAN ENOUGH ROOM FOR THE SMALL OR BIG
BLOCK MOTOR

751000 CHEVROLET & GMC PICKUP & PANEL TRUCK



FRONT FLOOR

COMPLETE WITH ALL THE BRACING AND SUPPORT BRACKETS - TRANSMISSION HUMP IS
DESIGNED TO CLEAR THE MODERN TYPICAL AUTOMATIC TRANSMISSIONS & WILL ALSO CLEAR
THE LOKAR FLOOR SHIFTER.

751003 FITS UP TO THE BITCHIN
FIREWALL LISTED ABOVE

751002 FITS UP TO A STOCK FIREWALL



THE OLD CAR CENTRE Phone: 604-888-4412 Fax: 604-888-7455

#3 - 20075 92A Avenue, Langley, B.C. Canada V1M-3A5

REAR FLOOR

CONTAINS ALL BEADS, SUPPORT BRACES, HARDWARE, SEALER AND INSTRUCTIONS. CUSTOM DESIGNED WITH A FLAT FLOOR TO WORK BEST WITH MORE MODERN, AFTER MARKET, OR BUCKET SEATS.

751004

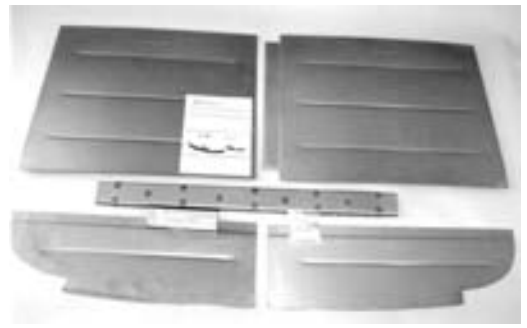

RADIATOR CORE SUPPORT

THIS KIT WAS DESIGNED AS A POSI-ALIGN RADIATOR CORE SUPPORT THAT IS A DIRECT BOLT-IN APPLICATION. CORE SUPPORT ALSO ALLOWS YOU TO MOUNT YOUR RADIATOR APPROX. 2 1/4" LOWER THAN STOCK, WHICH LETS YOU USE A FLEX FAN INSTEAD OF AN ELECTRIC FAN. INCLUDES ALL HARDWARE AND INSTRUCTIONS.

751035 CHEVY PICKUP AND PANEL TRUCK ONLY



INNER FENDER APRON KIT

THIS KIT IS MADE OF 18 GAUGE COLD ROLLED STEEL. EACH APRON COMES WITH A ROW OF LOUVERS TO ALLOW HEAT TO ESCAPE INTO THE WHEEL WELL. THIS IS A BOLT IN KIT NO WELDING IS REQUIRED. ALL HARDWARE AND INSTRUCTIONS ARE INCLUDED. CAN BE USED WITH FIREWALL 751000 AND RADIATOR CORE SUPPORT 751035 TO TAKE ON A NEW APPEARANCE OR INSTALLED AGAINST A STOCK FIREWALL WITH A SMALL AMOUNT OF TRIMMING TO THE BACK EDGES

751040 CHEVY PICKUP AND PANEL TRUCK ONLY

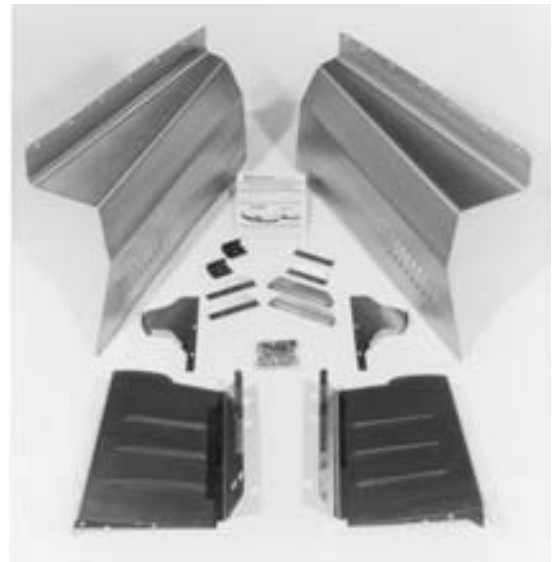

COWL VENT FILLER

751023

751024 SIDE VENT FILLER



CHEVY PICKUP 1947 to 1972

www.oldcarcentre.com

SUREFIT BY VINTAGE AIR HEAT/AIR/DEFROST UNITS



COMPLETE KIT INCLUDES EVAPORATOR, HOSE KIT, CONDENSER, DRIER, COMPRESSOR AND BRACKET. UNITS ARE MADE TO FIT BEHIND THE DASH FOR CUSTOM APPEARANCE. EVAPORATOR UNIT AVAILABLE SEPARATELY. PLEASE CALL FOR PRICING AS THERE ARE DIFFERENT OPTIONS AVAILABLE.

1947-55
1955-59
1960-72

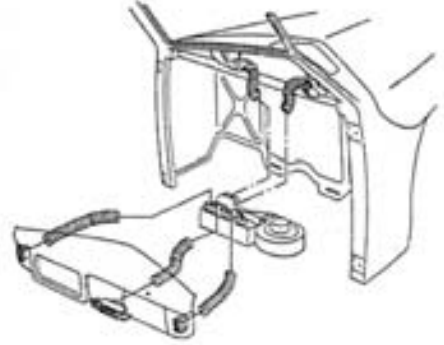

COMPACT HEATER AND HEATER WITH DEFROST

COMPLETE WITH THREE SPEED BLOWER, HEATER CONTROL VALVE, ROTARY CONTROLS AND WIRING HARNESS. DEFROST UNIT INCLUDES DUCTS AND HOSES

50515VUH HEATER ONLY

50615VUH HEATER C/W DEFROSTER



***WE ALSO SELL THE VARIOUS COMPONENTS FOR YOUR AIR CONDITIONING NEEDS SEPARATELY. PLEASE FEEL FREE TO CALL OR WRITE FOR PRICING OR INFORMATION.**



GLIDE ENGINEERING SPLIT BACK SEAT ASSEMBLY

BACK RECLINES AND FLIPS FORWARD AND BOTTOM LIFTS UP. COMPLETE WITH SLIDERS AND BRACKETS TO MOUNT TO FACTORY SEAT RISOR.

1947-54
9254

F-49 FOAM KIT FOR ABOVE



THE OLD CAR CENTRE Phone: 604-888-4412 Fax: 604-888-7455

#3 - 20075 92A Avenue, Langley, B.C. Canada V1M-3A5

POWER WINDOW CONVERSION KIT

EVERYTHING IS INCLUDED IN THIS KIT TO CONVERT TO POWER WINDOWS, WITH TEMPLATES, WIRING HARNESSES, NEW CHROME GM SWITCHES AND INSTRUCTIONS - SPECIFY YEAR OF VEHICLE
9270

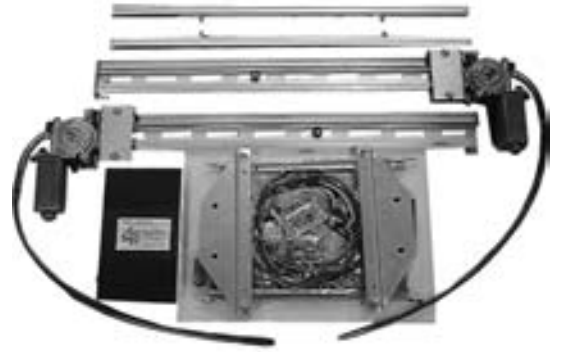

BILLET ALUMINUM INSIDE HANDLES

SOLD IN PAIRS

1947-72

9451 WINDOW HANDLES

9450 DOOR HANDLES



BILLET SPECIALTIES

46520 WINDOW HANDLES



45520 DOOR HANDLES



SMART ANTENNA

- REPLACES AM/FM OUTSIDE ANTENNA
- PATENT PROTECTED TECHNOLOGY
- SUPERIOR SIGNAL TO NOISE RATION
- TOTALLY NON-DIRECTIONAL - WORKS 360'
- NO DRILLING OR GROUNDING
- NO DAMAGE BY VANDALISM, ACCIDENTS OR CORROSION
- QUICKLY AND EASILY INSTALLED
- LIFE TIME WARRANTY



9000A ANTENNA ASSEMBLY



CHEVY PICKUP 1947 to 1972

www.oldcarcentre.com



FLUSH MOUNT TAILLIGHTS

IF YOU'RE GOING TO FLUSH MOUNT YOUR LIGHTS WE HAVE WHAT YOU'LL NEED. OUR LIGHT KITS ARE CRAFTED FROM 16 AND 20 GAUGE STEEL. HOUSINGS AND SOCKETS ARE RUBBER SEALED TO KEEP THE WEATHER OUT. DOUBLE FILAMENT 1157 BULBS ILLUMINATE OUR PRISMATIC LENSES AND GIVE YOU STOP, TURN AND TAILLIGHTS. YOU ARE SURE TO BE SEEN FROM THE REAR WHEN YOU LIGHT IT UP WITH HAGAN FLUSH MOUNT TAILLIGHTS, AND THIRD BRAKE LIGHTS! AVAILABLE FROM 2 3/4" LONG TO 16" LONG WITH EITHER STANDARD OR LOW PROFILE BOXES. LENSES ARE AVAILABLE WITH A SINGLE, DOUBLE, ANGLED OR RECTANGULAR SHAPE. PARKLITES ARE 2 3/4" LONG WITH A SINGLE SLOT AMBER LENS.

- 7636 PARK LITE
- 7637 LOW PROFILE BOX
- 7638 STANDARD BOX
- 7639 SINGLE SLOT LENS
- 7640 DOUBLE SLOT LENS
- 7641 ANGLE SLOT LENS
- 7642 RECTANGULAR LENS
- 7645 BOWTIE LENS
- 7646 TEARDROP LENS
- 7647 OVAL LENS
- 7648 TRIPLE LENS
- 7649 DOUBLE LENS

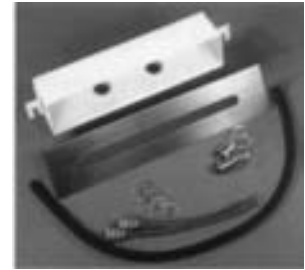
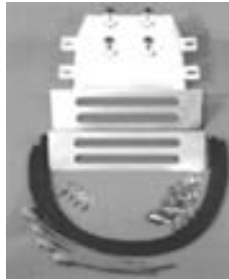

WIRING KITS

CLASSIC UPDATE SERIES BY AMERICAN AUTOWIRE

KIT INCLUDES THE ORIGINAL HEADLIGHT AND PARKING LIGHT, BOOT, TUBE, GROMMETS AND LIGHT SOCKETS AS REQUIRED.

THE COMPLETELY NEW 18 FUSE, 21 CIRCUIT, FUSE BOX SYSTEM THAT THE CLASSIC UPDATE SERIES IS BUILT AROUND COMES COMPLETELY READY TO INSTALL UNDER DASH. THE HARNESS THAT IS MOUNTED UNDER THE DASH WAS ASSEMBLED TO ACCOMMODATE THE FACTORY DASH SUPPORTS WHILE NOT INTERFERING WITH ANY AFTERMARKET EQUIPMENT THAT YOU WILL INSTALL UNDER THE DASH NOW OR IN THE FUTURE.

ORIGINAL DOME LIGHTING IS INCLUDED IN THE WIRING SYSTEM. ADDITIONALLY, THE CLASSIC UPDATE SERIES INCLUDES UNDERDASH LIGHTING AND ENOUGH SPARE CIRCUITS TO ADD POWER DOOR LOCKS, POWER WINDOWS AND MUCH MORE!

THE OLD CAR CENTRE Phone: 604-888-4412 Fax: 604-888-7455

#3 - 20075 92A Avenue, Langley, B.C. Canada V1M-3A5

ORIGINAL DESIGN REAR BODY WEATHERPROOF BOOT AND TUBE ASSEMBLIES AND ORIGINAL DESIGN LIGHT SOCKETS MAKE ATTACHMENT TO ORIGINAL OR REPRODUCTION TAIL LIGHT ASSEMBLIES AN EASY PLUG-IN. EVEN CUSTOM APPLICATIONS REQUIRE THESE ASSEMBLIES FOR WEATHER PROTECTION!

ALL ORIGINAL CONNECTORS ARE PROVIDED FOR CONNECTING TO ALL ORIGINAL EQUIPMENT: LIGHTING, FUEL SENDER, OPTIONAL BACK-UP LIGHTS, LICENCE LIGHTS, AND EVEN FOR ADDING A THIRD BRAKE LIGHT.

SIMPLE 3 7/8" MALE AND FEMALE CONNECTORS ARE PROVIDED TO CONNECT ANY STEERING COLUMN FROM THE ORIGINAL TO FULLY MODIFIED. THE WIRING HARNESS IS COMPLETELY GM COLOR CODED AND WE EVEN SUPPLY THE COLOR CODE TO ADAPT THE ORIGINAL SYSTEM.

ALL THE CLASSIC UPDATE SERIES HARNESS SYSTEMS COME READY TO CONNECT TO THE UPDATED SI ALTERNATOR AND ORIGINAL COIL/DISTRIBUTOR OR MOST ANY AFTERMARKET SYSTEM WITHOUT ADDITIONAL PARTS.

1947-55
500467
1955-59
500481
1960-66
500560

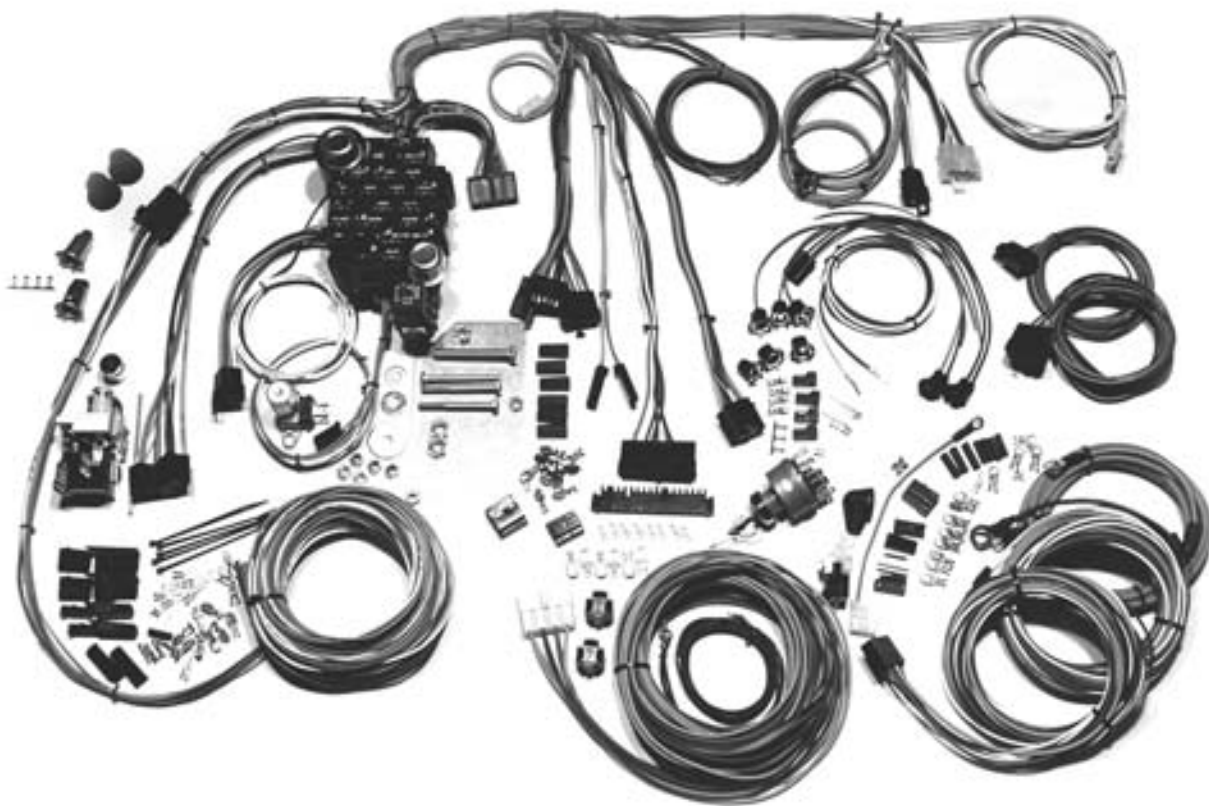

CHEVY PICKUP 1947 to 1972

www.oldcarcentre.com



FLOOR SHIFTERS

AVAILABLE TO FIT TH-350, TH-400, 700R, POWERGLIDE, FORD C-4, C-6, A.O.D., FMX AND MOPAR 727 MOPAR TRANSMISSIONS. SHIFTERS COME WITH REVERSE AND NEUTRAL SAFETY LOCKOUT BUTTON IN SHIFT LEVER KNOB. ADJUSTABLE WITH 12 FRONT TO REAR MOUNTING POSITIONS TO SUIT EACH INDIVIDUAL NEED. LEVER AVAILABLE IN 23", 16", 12", 8" AND 6" LENGTH WITH ORIGINAL MUSHROOM STYLE KNOB IN BLACK OR BRUSHED ALUMINUM OR WITH MACHINED ALUMINUM KNOB TO MATCH LOKAR'S TRANSMISSION DIPSTICKS. THE NOSTALGIA SHIFTER IS 23" LONG WITH TWO BENDS IN THE LEVER, FOR A NOSTALGIC HOT ROD LOOK. NEW NOSTALGIC 8 BALL KNOB NOW AVAILABLE. WHEN ORDERING SPECIFY TRANSMISSION STYLE, STICK LENGTH AND TYPE OF KNOB. FOR CHRYSLER APPLICATIONS PLEASE ADD \$30.00.



- 9405 LOKAR SHIFTER
- 9445 NOSTALGIA SHIFTER

HAND BRAKE

AVAILABLE IN 11" OR 16" LENGTH TO BOLT TO LOKAR FLOOR SHIFTER
9408 SHIFTER MOUNTED HAND BRAKE - SPECIFY LENGTH



LOKAR COLUMN SHIFT LINKAGE

SIMPLIFY CONNECTING YOUR COLUMN SHIFT TO YOUR TRANSMISSION WITH A LOKAR MACHINED BILLET ALUMINUM ADJUSTABLE COLUMN SHIFT LINKAGE KIT. OUR RIGID, CLEAN LINE DESIGN ALLOWS THE PROPER RATIO ADJUSTMENT BETWEEN THE TRANSMISSION AND THE INDICATOR ON THE COLUMN.

- 1800 ADJUSTABLE BILLET COLUMN ARM KIT TH350/400/700/200/4L60/4160E/4L80E
- 1801 ADJUSTABLE BILLET COLUMN ARM KIT FORD C4/C6
- 1802 BILLET COLUMN ARM ONLY TH350/400/700
- 1803 BILLET COLUMN ARM ONLY FORD C4/C6



LOKAR'S HI-TECH BRAIDED STAINLESS TRANSMISSION DIPSTICK

YOU CAN HAVE UNLIMITED FLEXIBILITY WITH OUR TEFLON
LINED BRAIDED STAINLESS TRANSMISSION DIPSTICK.



KIT COMES COMPLETE WITH BRAIDED STAINLESS OUTER HOUSING
AND HEAT RESISTANT E-Z TO READ TEFLON INNER ROD, INNER ROD
IS STAMPED WITH APPROPRIATE TRANS FLUID LEVELS. MACHINED
ALUMINUM HANDLE AND ALUMINUM FITTING COMPLIMENT LOKAR'S
FLEXIBLE ENGINE DIPSTICKS. DIPSTICK FUNNEL ADAPTOR INCLUDED IN KIT FOR ASSISTANCE
IN FILLING. DESIGNED FOR "PUSH IN" STYLE TRANSMISSIONS. DIPSTICK SEALS WITH O-
RING AND AUTOMOTIVE SILICONE SEALANT. APPLICATIONS IN BOTH FIREWALL MOUNT AND
TRANSMOUNT. FIREWALL MOUNT MEASURES 24" IN LENGTH. TRANSMOUNT MOUNTS TO THE
BELL HOUSING AND THE LENGTH VARIES ACCORDING TO THE TRANSMISSIONS, CALL FOR
INFORMATION ON CUSTOM ORDERS. SPECIFY TRANSMISSION. AVAILABLE FOR GM TH-350,
TH-400, TH-200, POWERGLIDE, 700R, 200R, 4L80E, 4L60, 4L60E, FORD C-4, C-6, FMX, AOD, CHRYSLER
727 AND 904.

9415 FIREWALL MOUNT

9416 TRANS MOUNT

LOKAR'S STAINLESS STEEL HI-TECH KICKDOWN KITS

LOKAR'S U-CUT-TO-FIT BRAIDED STAINLESS TEFLON LINED CABLE IS DESIGNED WITH A
SPECIALLY EXTRUDED LINER FOR EXTENDED LIFE OF THE CABLE.

KICKDOWN FEATURES ALUMINUM FITTINGS WITH FERRULE TO ELIMINATE FRAYED CABLE
ENDS. KICKDOWNS ARE ADAPTABLE FOR ALL TYPES OF MANIFOLDS INCLUDING TUNNEL
RAM, BLOWER MANIFOLDS AND WEBER INDUCTION SYSTEMS. MOUNT OUR KICKDOWN WITH
OUR STAINLESS STEEL CARBURETOR BRACKET AND SPRINGS (SOLD SEPARATELY). ALL UNITS
ARE AVAILABLE IN BLACK TEFLON LINED HOUSING UPON SPECIAL REQUEST. COMPLETE
INSTRUCTIONS INCLUDED IN KIT. SPECIFY TRANSMISSION TYPE. AVAILABLE FOR G.M. TH-350,
700R, TH-200, 200R, 4L60, POWER GLIDE, FORD C-4, C-6, FMX, AOD, CHRYSLER 727B 904, 518.

9422 HI-TECH KICKDOWN KIT -SPECIFY TRANS

9423 BLACK 350 KICKDOWN KIT C/W BRACKET

9403 TUNEPORT HI-TECH TH 350 KICKDOWN KIT

9404 T-400 ELECTRIC KICKDOWN

9434 TUNEPORT 700R KICKDOWN KIT

9460 LSI & RAMJET 36" HI-TECH THROTTLE CABLE



CHEVY PICKUP 1947 to 1972

www.oldcarcentre.com

FLEXIBLE ENGINE DIPSTICKS

FLEXIBLE ENGINE DIPSTICK DESIGNED TO COORDINATE WITH LOKAR'S FLEXIBLE TRANSMISSION DIPSTICK.
SLIM DESIGN ALLOWS MOUNTING INSIDE HEADERS.
APPLICATIONS AVAILABLE FOR G.M. AND FORD.
E-Z READ STICK FOR ACCURATE MEASURE OF ENGINE OIL.

- 9419 PRE-80 SB CHEV - (NO TUBE REQUIRED)
- 9431 1980-UP SB CHEV - FLEXIBLE DIPSTICK
- 9432 PRE-80 SB CHEV FLEXIBLE DIPSTICK
- 9436 BIG BLOCK CHEV DIPSTICK
- 9497 302 FORD DIPSTICK
- 9498 351 FORD DIPSTICK - SCREW INTO PAN
- 9430 502 BIG BLOCK CHEV
- 9442 FORD BIG BLOCK 460 & 514 CRATE MOTORS ONLY
- 9446 LSI
- 9447 VORTEC RAMJET 350



LOKAR'S THROTTLE CABLES

ALL LOKAR THROTTLE CABLES ARE AVAILABLE IN EITHER STAINLESS STEEL BRAIDED HOUSING, OR BLACK HOUSING. THEY ARE DESIGNED WITH A SPECIALLY EXTRUDED LINER FOR EXTENDED LIFE OF CABLE. CABLES ARE EQUIPPED WITH ALUMINUM FITTINGS AND ALUMINUM FERRULE TO ELIMINATE FRAYING. "U-CUT-TO-FIT" OUTER HOUSING IS AVAILABLE IN 24" OR 36" IN LENGTH WITH A "U-CUT-TO-FIT" STAINLESS INNER WIRE. CLEVIS IS DESIGNED WITHOUT COTTER PINS OR SET SCREWS. ADAPTS TO FACTORY AND AFTERMARKET PEDALS. CUSTOM LENGTHS AVAILABLE UPON REQUEST. CABLES MOUNT NICELY WITH LOKAR'S STAINLESS STEEL CARBURETOR BRACKET AND SPRINGS (SOLD SEPARATELY). KITS COMPLETE WITH INSTALLATION INSTRUCTIONS.

- 9420 HI-TECH THROTTLE KIT
- 9420L HI-TECH 36" LONG CABLE
- 9421L BLACK 36" LONG CABLE
- 9421 BLACK THROTTLE KIT
- 9401 TUNE PORT THROTTLE BRACKET
- 9402 TUNE PORT THROTTLE CABLE (ALSO LTI & LT4)



STAINLESS STEEL THROTTLE CABLE BRACKET & SPRINGS

STAINLESS BRACKET MOUNTS TO REAR OF HOLLY, EDELBROCK, AFB, QUADRAJET AND IN-LINE DUAL QUAD CARBURETORS.

STAINLESS BRACKETS AND GM DESIGNED DUAL STAINLESS SPRINGS ARE USED TO MOUNT LOKAR'S THROTTLE CABLE AND KICKDOWN ASSEMBLIES.

NEW DESIGN INCLUDES TEARDROP EXTENDER TO GIVE MORE CLEARANCE ON THE EDELBROCK CARBS.

9417 THROTTLE BRACKET ASSEMBLY

9418 SPRINGS ONLY



XL SERIES CHROMED STEEL THROTTLE ASSEMBLIES

LOKAR XL SERIES CHROMED STEEL GAS PEDAL WITH RUBBER INSERTS IS DESIGNED JUST LIKE THE STANDARD SIZE LOKAR CHROME STEEL GAS PEDAL, BUT IT IS EXTRA LARGE FOR THOSE SEEKING MORE COMFORT AND SAFETY. GAS PAD IS SPRING LOADED LIKE OEM DESIGN AND REMOVABLE LOWER ARM IS SPLINED FOR VERSATILITY IN MOUNTING TO THE RIGHT OR LEFT OF THE MOUNTING BRACKET. MATCHING XL SERIES CHROMED STEEL BRAKE PADS MOUNTS WITH A 1/2 X 20 STUD BUILT IN TO THE BACK OF THE PAD. USE THE STANDARD CHROME STEEL DIMMER THAT FITS BOTH CHEVY AND FORD WITH THE XL SERIES GAS AND BRAKE. THIS IS BOTH AFFORDABLE AND DURABLE AND MEETS THE NEEDS OF THOSE "NO BILLET" HOBBYISTS.

SG-6016 XL CHROMED STEEL THROTTLE PEDAL SPRING LOADED

SG-6017 XL CHROMED STEEL BRAKE PAD



CHEVY PICKUP 1947 to 1972

www.oldcarcentre.com



TILT FLOOR SHIFT STEERING COLUMNS

ADD THE CONVENIENCE AND RELIABILITY OF A NEW COLUMN BUILT SPECIFIC FOR YOUR GM OR GMC TRUCK. THIS STEERING COLUMN IS NOT A UNIVERSAL COLUMN THAT REQUIRES MODIFICATION OF YOUR ORIGINAL VEHICLE TO INSTALL. SIMPLY REMOVE YOUR OLD COLUMN, SAVING YOUR ORIGINAL UNDER-DASH MOUNT AS WELL AS THE ORIGINAL FLOOR MOUNT. USING ONE OF OUR INSTALLATION KITS, INSTALL YOUR STEERING COLUMN IN PLACE OF THE OLD. ADD AN AFTERMARKET WHEEL AND THE GRIPPING SURFACE OF THE NEW WHEEL WILL BE IN THE SAME LOCATION AS THE ORIGINAL. EACH COLUMN IS BACKED BY A LIMITED LIFETIME WARRANTY AND IS AVAILABLE IN MANY DIFFERENT FINISHES.

STANDARD FEATURES:

- * SELF-CANCELING TURN SIGNALS
- * 4-WAY FLASHERS
- * KNOBS AND HANDLES
- * WIRING HARNESS
- * 1960-72 = 3/4" 36 SHAFT

1960-66

- 1120650010 PAINTABLE STEEL
- 1120650020 CHROME
- 1070650030 BRUSHED ALUMINUM
- 1070650040 POLISHED ALUMINUM

1967-72

- 1120657010 PAINTABLE STEEL
- 1120657020 CHROME
- 1070657030 BRUSHED ALUMINUM
- 1070657040 POLISHED ALUMINUM



ALONG WITH THE COLUMNS WE HAVE A COMPLETE LINE OF COLUMN DROPS - FLOORMOUNTS - STEERING WHEELS AND ADAPTORS. - PLEASE CALL FOR INFO.

THE OLD CAR CENTRE Phone: 604-888-4412 Fax: 604-888-7455

#3 - 20075 92A Avenue, Langley, B.C. Canada V1M-3A5

TILT COLUMN SHIFT STEERING COLUMNS

WITH THE SAME SPECS AS THE TILT FLOOR SHIFT VERSION, THIS COLUMN SHIFT COLUMN IS JUST AS EASY TO INSTALL. THE COLUMN HAS BEEN MODIFIED TO PUT YOUR AFTERMARKET WHEEL IN THE SAME LOCATION AS THE ORIGINAL. THE COLUMN COMES COMPLETE WITH A NEUTRAL SAFETY SWITCH, HOW-EVER AN INDICATOR IS NOT INCLUDED. THE SHIFT PATTERN ON THE COLUMN WILL ALLOW YOU TO USE EITHER A 3-SPEED OR 4-SPEED TRANSMISSION (EXCEPT EARLY POWER GLIDE, BECAUSE THEY HAVE A REVERSE PATTERN TRANSMISSION). A SHIFT LINKAGE IS REQUIRED FOR INSTALLATION AND WILL ATTACH TO THE LOWER SHIFT LINKAGE PROVIDED ON THE COLUMN. EACH COLUMN IS BACKED BY A LIMITED LIFETIME WARRANTY AND IS AVAILABLE IN MANY DIFFERENT FINISHES.

STANDARD FEATURES:

- * SELF-CANCELING TURN SIGNALS
- * 4-WAY FLASHERS
- * KNOBS AND HANDLES
- * WIRING HARNESS
- * 1960-72 = 3/4" 36 SHAFT

1960-66

- 1140650010 PAINTABLE STEEL
- 1140650020 CHROME
- 1150650030 BRUSHED ALUMINUM
- 1150650040 POLISHED ALUMINUM

1967-72

- 1140657010 PAINTABLE STEEL
- 1140657020 CHROME
- 1150657030 BRUSHED ALUMINUM
- 1150657040 POLISHED ALUMINUM



CAR COVERS

WE OFFER A VARIETY OF CUSTOM MADE COVERS FOR YOUR TRUCK. THEY ARE AVAILABLE IN VARIOUS TYPES OF MATERIALS THESE ARE MADE TO FIT, NOT A UNIVERSAL TYPE. PLEASE FEEL FREE TO CALL OR WRITE FOR PRICING AND AVAILABILITY FOR YOUR TRUCK.



CHEVY PICKUP 1947 to 1972

www.oldcarcentre.com

CALIFORNIA CAR DUSTERS

SPECIALLY TREATED COTTON STRANDS

LIFT DUST WITHOUT SCRATCHING YOUR PAINT. LASTS FOR YEARS AND COMES WITH HANDY VINYL CARRYING CASE . IT REALLY WORKS!

8955

8955M MINI DUSTER



WATER BLADE

SOFT SILICON BLADE THAT WILL NOT SCRATCH YOUR PAINT. QUICKLY REMOVES WATER FROM YOUR TRUCK AFTER WASHING.

8955W WATER BLADE



WENOL METAL POLISH

WENOL - THE ORIGINAL DEEP CLEANING METAL POLISH.

WENOL MAKES RESTORING OLD METALS EASY. QUICKLY REMOVES SURFACE RUST, OXIDATION, ANIMAL STAINS, SOAP AND HARD WATER SPOTS IN JUST MINUTES. RECOMMENDED FOR GOLD, SILVER, BRASS, COPPER, ALUMINUM, TIN, PAINTED SURFACES AND FIBREGLASS.

NEW AUTO WENOL - TRUE "SHOW QUALITY" METAL POLISH.

A ULTRA SOFT METAL POLISH WHICH PROVIDES A HIGH GLOSS, SHOW QUALITY LUSTRE TO ALUMINUM, CHROME AND STANLESS STEEL.



9895 ORIGINAL WENOL

9896 NEW WENOL

WESTLEYS BLECHE - WITE WHITEWALL CLEANER

THE WORLD'S NO. 1 TIRE CLEANER. FOR THE BRIGHTEST WHITE WALL'S USE WESTLEY'S.

BLU-555 32 OZ. WHITEWALL CLEANER



BOOKS AND MANUALS

REPRINTS OF ORIGINAL FACTORY MANUALS

ASSEMBLY MANUALS

47-1001 1947-55 FIRST SERIES
55-1001 1955-59
60-1001 1960-66
67-1001 1967-72

SHOP MANUALS

48-1002 1948-53
47-1002-GMC 1947-54 GMC
54-1002 1954
55-1002-1 1955 1ST SERIES
55-1002 -2 1955 2ND SERIES
55-1002-GMC 1955-59 GMC
56-1002 1956
57-1002 1957
58-1002 1958
59-1002 1959
60-1002 1960
61-1002 1961
63-1002 1963
64-1002 1964 SUPPLEMENT
65-1002 1965 SUPPLEMENT
66-1002 1966 SUPPLEMENT
67-1002 1967 SUPPLEMENT
68-1002 1968
69-1002 1969
70-1002 1970
71-1002 1971
72-1002 1972

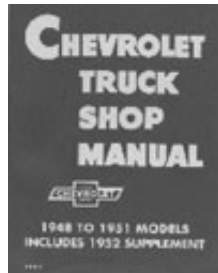

OWNERS MANUALS

47-1003 1947
48-1003 1948
49-1003 1949
50-1003 1950
51-1003 1951
52-1003 1952
53-1003 1953
54-1003 1954
55-1003-1 1955 1ST SERIES

55-1003-2 1955 2ND SERIES

56-1003 1956
57-1003 1957
58-1003 1958
59-1003 1959
60-1003 1960
61-1003 1961
62-1003 1962
63-1003 1963
64-1003 1964
65-1003 1965
66-1003 1966
67-1003 1967
68-1003 1968
69-1003 1969
70-1003 1970
71-1003 1971
72-1003 1972

REFERENCE BOOKS

137303 CHEVROLET PICKUPS

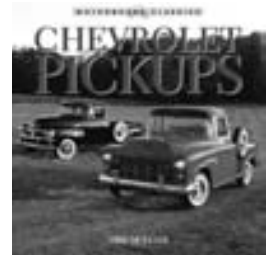

123273 CHEVY PICKUP TRUCKS

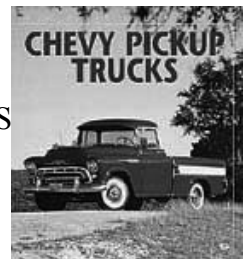

137250 HOW TO RESTORE YOUR CHEVY PICKUP

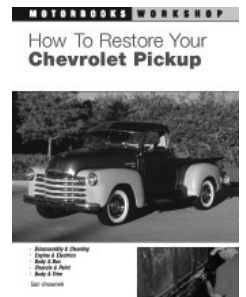

112474 CHEVY PICKUP 1946/72

1918-1994

119935 CHEVY PICKUP COLOR HISTORY

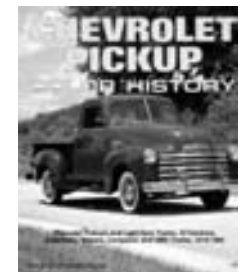

CHEVY PICKUP 1947 to 1972

www.oldcarcentre.com

Shop Photos



The Old Car Centre Show Room...

The front of our 6000 sq. ft. store has a large display of chassis and chassis parts along with bodies and accessories.

If you are in the area, please drop in and say hello!



- **Metal Garage Art Sign**
21" w x 15" high, 5 colour
Old Car Centre Metal Sign.....\$29.95 ea.

- **T-Shirts**
100% cotton imprinted with our logo in six colors

- **Sweat Tops**

- **Rodders Journal**



THE OLD CAR CENTRE Phone: 604-888-4412 Fax: 604-888-7455

#3 - 20075 92A Avenue, Langley, B.C. Canada V1M-3A5

Index

A

Accelerator Pedals & Parts	10
Accelerator Pedal - Lokar	78
Airbag Suspension - Rear	65
Air Conditioning Components.....	26
Air Conditioning-Vintage Air.....	71
Antenna - Stock.....	14
Antenna - (Smart Antenna).....	72
Anti-Rattle Kits.....	36
Arm Rests.....	31
Ash Tray Assembly/Parts.....	13
Assembly Manuals.....	82
Axle Bumpers	2

B

Backup Lens.....	20
Battery Box Parts	4
Battery Gauges.....	12
Beauty Rings.....	1
Bed Bolt Kits	58
Bed Cross Sills.....	55
Bed Hole Caps	54
Bed Mounting Pads/Blocks	57
Bed Panel - Front	53
Bed Sides	54
Bed Side Angle Strips	56-57
Bed Stake Pockets.....	55
Bed Strips Reinforcement.....	55
Bed Strip Sets.....	56
Bed Wood Sets.....	57
Blue Dots	19
Body Mouldings	48-49
Books & Manuals	82
Brake Parts & Pedal Parts.....	1-2
Brakes (Custom)	59-61
Bumpers & Parts.....	38-40
Bumpers - Briz (Custom).....	69

C

Cab Interior Screw Kits	29
Cab Mounting Kits.....	4
Cab Windlace.....	32
Car Care - Cleaners/Dusters.....	81
Car Covers	80
Cargo Light	21
Carpet Kits	29

Cat Whiskers.....	36
Choke Cables & Knobs.....	9
Clutch Parts.....	5
Clutch Pedal Parts.....	1-2
Column Shift Parts.....	5-6
Column Shift Linkage -Lokar.....	75
Cowl Vent Parts.....	32
Cross Sills	55
Custom Parts.....	59-81

D

Dash Parts	10-11
Dashes (Dakota Digital).....	68
Disc Brake Kits (Custom).....	59-61
Dome Light Parts	21
Door Bumper Sets.....	34
Door Emblems	49
Door Glass Channel/Panel Truck.....	38
Door Handles	34
Door Handles (Billet).....	72
Door Hinge & Latches	33
Door Locks.....	35
Door Panels - Interior/Parts	28-29
Door Parts	32-35
Door Relays	34
Door Seals	32
Door Shells - Exterior	48
Door Sill Plates	32
Door Window Seals	36

E

Emergency Brake Parts.....	2
Engine Decals	5
Engine Dipsticks - Lokar	77
Engine Mounts	4
Emblems - Door.....	49
Emblems - Fender	49-50
Emblems - Tailgate	51-52

F

Fender Emblems	49-50
Fenders - Fiberglass	46
Fenders - Steel.....	46
Fender Parts	47
Fender Welt	47
Firewall Pad	30

Floor Mats.....	29
Floor Shifter - Lokar	75
Fuel Guages	12
Fuel Systems Parts	8-9
Fuel Tanks (Stock)	8
Fuel Tanks - Custom	67-68

G

Gas Caps	9
Gas Cap (Cool Cap).....	67
Gas Gauges	12
Gas Pedals & Parts.....	10
Gas/Brake Pedal - Lokar XL	78
Gas Tanks & Related.....	8-9
Gas Tanks - Custom	67-68
Gauges - Stock	11-12
Gauges - Classic Instruments.....	68
Glass Run Channel.....	36
Glove Box & Parts.....	30-31
Glove Box Door Emblems.....	31
Grill Assemblies.....	6-7
Grill Emblems.....	7
Grill Valance	7

H

Hand Brake - Lokar	75
Headlight Parts.....	15-16
Headlight Switch & Knobs	15
Headliner & Parts.....	28
Heater Parts.....	25
Heater - (Compact Heater).....	71
Hoods & Parts.....	22-23
Hood Emblems.....	23
Horn Parts	3-4
Hub Caps.....	1

I

Ignition Indicator Plate	13
Ignition Switch & Keys	13
Independent Front Suspension.....	62
Inside Door Handles	34
Inside Rear View Mirror	26
Instrument Panels & Related..	10-11
Interior Parts.....	28-29

K

Kick Panels	29
Kickdown Kits - Lokar	76

L

Leaf Spring Kit (Custom)	65
Licence Lens	20
Licence Plate Brackets	21
Licence Plate Lamp Assembly.....	21
Link Kit (Custom).....	65

M

Master Cylinder Floor Plug	1
Mirrors Interior	26-27
Mirrors Exterior	27
Motor Mounts - Original.....	4-5
Motor Mount Conversion	66
Mouldings	48-49
Mouldings - Tailgate	53
Must.II- A-Arms	63-64
Must.II-Air Spring Retro-Kit.....	64
Must.II- Disc Brake Kit	63
Must.II- Dropped Spindles.....	64
Must.II- Front Crossmember	61
Must.II Kit - Hub to Hub	62
Must.II- Rotor/Bearing Kits.....	63

O

Oil Pressure Gauges	12
Owners Manuals	82

P

Parking Brake Parts.....	2
Parklight Assemblies	16
Parklight Lens & Parts	17
Power Window Conver. Kit	72
Proportioning Valves.....	61

R

Radiator Support Cushions	4
Radiator Supports/Mount Pads....	40
Radiator (Walker)	67

Radios & Parts	14
Rear Parallel Leaf Spring Kit.....	65
Rear Parallel Link Kit	65
Rear View Mirrors	26-27
Rear Window Chrome.....	38
Rear Window Seals	38
Repair Panels (1947-55)	41
Repair Panels (1955-59).....	42-43
Repair Panels (1960-66)	43-44
Repair Panels (1967-72)	44-45
Repair Panels - Bitchin	69-70
Residual Valve	61
Roll Pan / Front.....	39
Roll Pan / Rear.....	40
Running Boards	47
Running Board Seals.....	48
Running Board Splash Apron	47

S

Seat Assembly - Split Back.....	71
Seat Back / Cardboard	29
Seat Upholstery Kits	29
Seatbelt Assemblies	29
Sheet Metal Repair Panels	41-45
Sheet Metal - Bitchin -	69-70
Shifter Parts.....	5-6
Shocks (Coil-Over)	66
Shop Manuals.....	82
Side Marker Lights	18
Speaker Package/Grill Cover	14
Speedometer Gauges & Decals....	11
Speedometer Parts.....	11-12
Splash Apron Running Board	47
Starter Pedal Parts	13
Starter Return Spring	13
Stake Pockets	55
Steering Column Parts	3
Steering Columns - Ididit.....	79-80
Steering Wheels	3
Step Plates.....	48
Sun Visor & Parts.....	28
Sun Visor - Exterior	42

T

Tachometer Gauge	12
Tailgates	51
Tailgate Chains.....	52

Tailgate Decals & Letters.....	51-52
Tailgate Mouldings	53
Tailgate Related Parts	52-53
Taillight Assemblies.....	18
Taillight Parts	18-20
Taillights -Hagan Flush Mount....	73
Temperature Gauges	12
Throttle Cables & Knobs	9
Throttle Cables - Lokar.....	77-78
Transmission Crossmember	5-66
Trans. Crossmember Kit	66
Transmission Dipstick-Lokar.....	76
Trans. Indicator Parts	5
Turn Signal Levers.....	21
Turn Signal Related Parts	20-21
Turn Signal Switch	20

V

Vacuum Gauges	12
Vent Window Handles.....	37
Vent Window Parts.....	36-37
Vent Window Seals	36

W

Wheel Parts	1-2
Window Channel Kits.....	36
Window Division Bars	36
Window Door Seals	36
Window Handles & Parts.....	35
Window Handles - (Billet).....	72
Window Regulators.....	35
Window Seals	37-38
Windshield Seals.....	37
Windshield Trim	38
Wiper Arms & Blades	23-24
Wiper Motors	23
Wiper Parts & Knobs	23-25
Wiring	15
Wiring Kits - Classic Series ...	73-74